

# Emerging Ship Design Principles for Ammonia- Fueled Vessels



**Mærsk Mc-Kinney Møller Center**  
for Zero Carbon Shipping

# Contents

Executive summary .....	3	06 Regulatory outlook.....	19
01 Introduction .....	5	07 Ammonia ship technology systems .....	21
02 Ammonia properties.....	7	08 Vessel design options and considerations.....	24
03 Key design aspects.....	8	8.1 Fuel tank options .....	25
3.1 Safety measures.....	9	8.2 Fuel tank arrangements .....	26
3.2 Ammonia ship technology .....	9	8.3. Fuel system design options.....	30
3.3 Design options and optimization .....	9	8.4 Accommodation location and bridge design.....	33
3.4 Examples of ammonia-fueled vessels.....	10	09 Conclusion .....	35
04 Safety assessment tools during the design phase .....	13	10 The project team.....	36
05 Safety considerations.....	15	Abbreviations .....	37
5.1 General safety aspects for toxic areas .....	17	References .....	40
5.2 Hazardous areas .....	17	Appendices .....	41
5.3 Ventilation .....	18	A. Differences and gaps in current regulations .....	41
5.4 Leak detection .....	18	B. Ammonia fuel system components .....	43

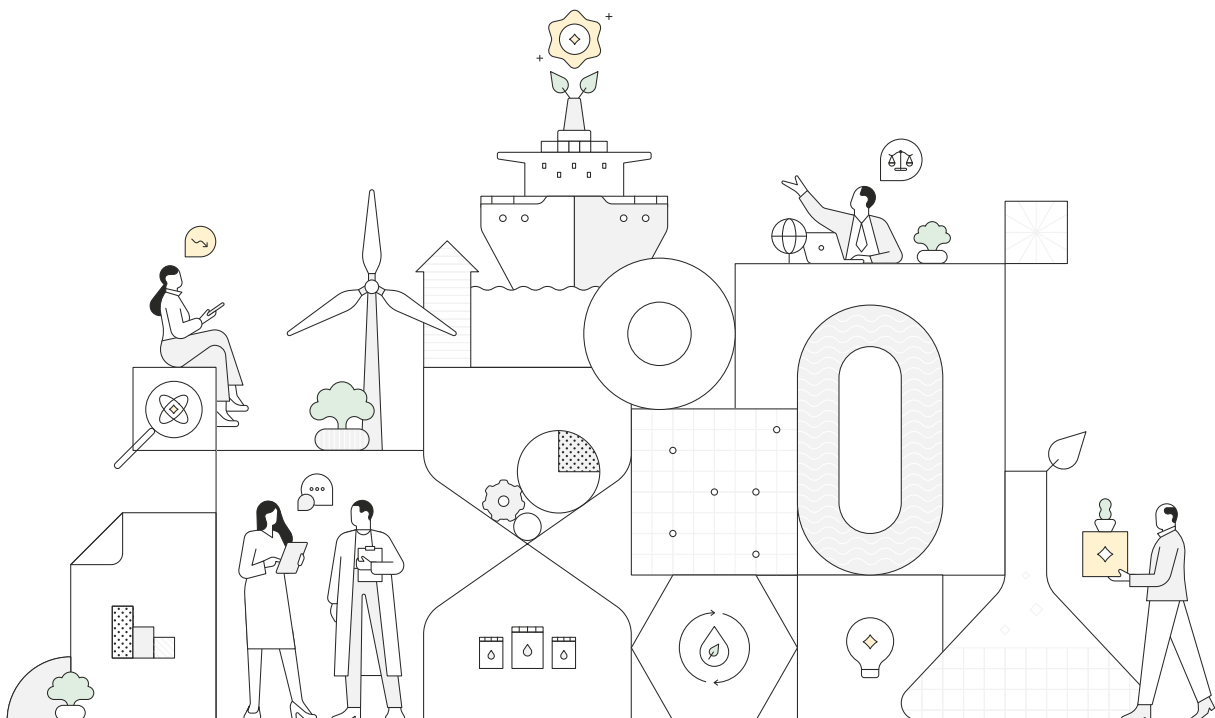

# Executive summary

As the shipping industry moves towards alternative fuels to meet decarbonization goals, ammonia emerges as a viable alternative fuel with high scalability and low greenhouse gas intensity. However, using ammonia as a marine fuel entails new ship design and safety considerations. The safe and efficient design of ammonia-fueled vessels is, therefore, paramount to the maritime industry's transition to zero-carbon shipping.

Due to ammonia's toxic and corrosive nature, ammonia-fueled vessels must be designed with meticulous attention to safety and material standards that aim to ensure an inherently safer design philosophy. Robust containment systems must be integrated into the vessel design to prevent leaks and releases, and emergency response systems and enhanced crew training protocols are critical to handling ammonia-specific incidents. Storage and handling systems must be capable of maintaining the high pressure and low temperatures necessary to keep ammonia in liquid form. Furthermore, the fuel supply systems must be carefully designed to ensure an adequate safety level on board, with attention paid to countermeasures for hazardous releases.

The end product of the ammonia-fueled vessel design process is determined by a multitude of fuel system interconnections and design features that must be taken into consideration. This endeavor requires a collaborative approach involving shipbuilders, ship designers, regulatory bodies, operators, and technology and system designers. Technological advancements, regulatory support, and shared best practices are essential to overcoming the challenges associated with ammonia as a fuel.

To this end, the Mærsk Mc-Kinney Møller Center for Zero Carbon Shipping (MMMCZCS) has developed this publication to shed light on the ship design best practices that will support the development of ammonia-fueled ship designs. The document serves as a generic framework that encapsulates key design considerations for container ships, bulk carriers, and tankers in the following areas.

---

## Safety considerations

The MMMCZCS has completed several ammonia studies which give an overview of the risks involved with ammonia-fueled vessels. Leveraging the industry's experience with liquid natural gas (LNG) as a marine fuel provides practical solutions for handling refrigerated gaseous fuels, but ammonia's toxicity also presents some new safety challenges. Key protective measures include double-wall structures, proper venting, alarms, automatic shutdown systems, efficient detection, early response practices, and remote monitoring to minimize crew exposure and ensure safe operation of the vessel. Features such as ventilation systems in tank connection spaces (TCS) and effective leak detection in enclosed spaces requiring multiple ammonia sensors are essential.

---

## Ammonia fuel technology

An ammonia-fueled vessel is equipped with ammonia fuel tank(s), supply system, bunker station, ammonia release mitigation system, and combustion technology. Depending on the specific ship design and type, additional considerations that determine the fuel system design are applicable, such as handling and ventilation (e.g., vent mast and inert system). This publication provides a comprehensive overview of the design considerations relating to ammonia fuel technology for different vessel types.

---

## Ship design considerations and optimization

In the detailed design stage, the fuel tank location and type should be decided with consideration of crew safety, distance to ventilation systems, transfer lines and bunker stations, ventilation of the TCS, and the cargo carrying capacity loss due to tank integration. The tank location must be optimized to minimize pipeline dimensions and routing while ensuring adequate protection. Factors such as the distance from crew accommodation to vent masts, protective measures against physical hazards, and accessibility during maintenance and emergencies must be considered to create a safe and efficient environment. Integrating advanced monitoring technologies supports these goals further by enabling effective space management with minimal direct human intervention.



This publication shares detailed guidance to assess the impact of different ship types on endurance requirements and overall ship performance. Additionally, we highlight various fuel system design options, including tank pressure management, drainage, accommodation design, and ammonia ventilation.

We are consistently seeking to leverage our modular knowledge and intelligence across disciplines from numerous collaborative industry projects with leading classification societies, flag states and industry

stakeholders, including shipyards, shipowners, operators, and designers. This document shares our latest learnings offering objective recommendations and industry practices on critical risk assessments, safety criteria, and ship design integration dilemmas beyond individual stakeholder vested interest. We envisage that the document will help the readers build confidence in the main considerations when designing an ammonia-fueled vessel, with emphasis on a high safety level onboard and on the optimal balance of performance and system design.



---

### Disclaimer

This publication has been prepared by Fonden Mærsk Mc-Kinney Møller Center for Zero Carbon Shipping ("Center") for informational purposes only. The content herein is based on studies, research, and analyses conducted by the Center, as well as publicly available information as of the date of publication. While the Center has made every effort to ensure the accuracy and reliability of the information presented, it does not guarantee or warrant, either expressly or impliedly, the completeness, accuracy, or suitability of this information for any specific purpose.

This publication is not intended to serve as technical, regulatory, legal or other advice. Readers are encouraged to consult with their advisors before making any decisions or taking actions based on the information contained herein. Compliance with applicable laws, regulations, and standards, including but not limited to those related to safety, environmental protection, and design requirements, remains the sole responsibility of the reader.

The Center disclaims all liability, whether in contract, tort (including negligence), or otherwise, for any damages, losses, errors, or injuries, whether direct, indirect, incidental, or consequential, arising from the use of, or reliance on, the information contained in this publication.

By accessing this publication, readers acknowledge and agree to the terms of this disclaimer and release the Center from any liability associated with the use of the information provided herein.



# 01

# Introduction

With its potential for low well-to-wake greenhouse gas (GHG) emissions and scalable production possibilities, ammonia has emerged as a promising alternative marine fuel pathway. As a result, there is a growing demand for design guidance for vessels with ammonia-driven main propulsion power and auxiliary systems.

To date, the Mærsk Mc-Kinney Møller Center for Zero Carbon Shipping (MMMCZCS) has carried out several extensive studies on the design and safety of ammonia-fueled ships, such as:

1. [Preparing Container Vessels for Conversion to Green Fuels, September 2022](#) <sup>1</sup>

2. [Managing Emissions from Ammonia-Fueled Vessels, March 2023](#) <sup>2</sup>

3. [Nordic Green Ammonia Powered Ships \(NoGAPS\), March 2023](#) <sup>3</sup>

4. [Recommendations for Design and Operation of Ammonia-Fueled Vessels Based on Multi-disciplinary Risk Analysis \(with Lloyd's Register \(LR\)\), June 2023](#) <sup>4</sup>

5. [Human Factors Considerations: Ammonia Fuel End-of-Stage Report \(with LR\), June 2023](#) <sup>5</sup>

6. [Concept design of a 15,000 TEU ammonia-fueled container vessel, September 2023](#) <sup>6</sup>

7. [Preparing tanker vessels for conversion to green fuels 2024](#) <sup>7</sup>

8. Concept design of an ammonia-fueled feeder vessel (upcoming report 2024)

This publication builds on findings from these previous MMMCZCS studies to present a comprehensive guide to the emerging solutions for ammonia-fueled vessels from a ship design perspective. The publication addresses oceangoing container ships, bulk carriers, and tankers, and does not consider coastal vessels and passenger ships.

Safety concerns are a major challenge for the adoption of ammonia as a marine fuel. A recent study provides advanced safety knowledge and understanding of ammonia handling and storage on board.<sup>4</sup> Our analysis further highlights the importance of several key design and operational factors that can improve safety on board ammonia-fueled vessels, such as the choice of ammonia fuel storage system, secondary containment mechanisms, ventilation, rapid and reliable sensors and alarms for ammonia leaks, and rapid and reliable shutdown of the fuel system.

Considering the shift toward dual-fuel propulsion in ship designs, there will be a need to create not only the correct equipment and control systems, but also new or revised procedures, work processes, and maintenance regimes. Within the Human Factors Considerations: Ammonia Fuel End-of-Stage Report, the MMMCZCS has provided a preliminary account of the human factors that should be addressed to prepare for the use of ammonia as a marine fuel.<sup>5</sup> The results point to the need for companies and the marine industry to apply human factors engineering principles, such as ergonomics, within the design of ammonia-fueled vessels to reduce potential crew exposure to ammonia.



The aim of this document is to help shipyards, ship designers, and operators/owners navigate through main decisions when developing new ammonia-fueled ship designs. Figure 1 presents the overall design flow leading to an ammonia-fueled vessel. The figure highlights the areas of ship integration and safety assessment that form the focus of this document.

Although many of the design aspects relevant to ammonia are already known from gaseous and low-flashpoint fuels, this document covers the ammonia liquid gas storage, handling, and safety aspects. This is to ensure that the readers who are not acquainted with alternative fuels such as methane can obtain a basic understanding of the design of gaseous fuel systems.

The document opens with a review of the key properties of ammonia (Section 2) and the key design aspects of ammonia-fueled vessels, including some example vessel designs (Section 3). This is followed by

five main sections designed to enable easy access for readers to the sections of interest, as follows:

- Tools to assess ammonia safety during the design phase (Section 4)
- Safety considerations (Section 5)
- Regulatory outlook (Section 6)
- Ammonia ship technology systems (Section 7)
- Vessel design options with key considerations for ammonia fuel systems (Section 8)

Finally, the conclusion (Section 9) briefly summarizes the overall key messages of the document, and extensive further background and analytical details are supplied in two appendices: Appendix A focuses on a regulatory gap analysis that supplements Section 6, while Appendix B elaborates with comprehensive descriptions of the technology on board and the pertinent design practices.

Figure 1: Design flow for ammonia-fueled vessels.

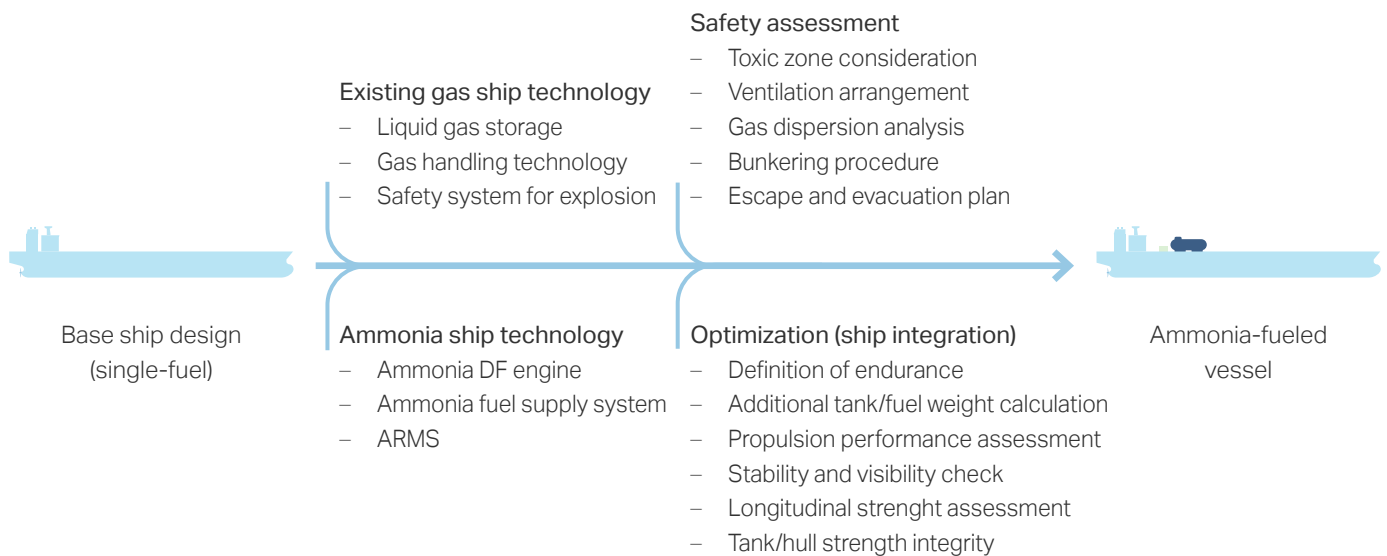

DF = dual-fuel, ARMS = ammonia release mitigation system



# 02

## Ammonia properties

Figure 2 summarizes the ammonia fuel properties that need to be taken into account in the ship design process and throughout the life cycle of the vessel.

Figure 2: Properties of ammonia.



**Highly soluble in water:** Solubility in water 530g/L (20 °C)\*\*  
Anhydrous ammonia is hygroscopic i.e. attracts water.



**Flammable, but hard to ignite:** Relatively high minimum ignition energy. Relatively high auto-ignition temperature of 650 °C  
Lower Explosive Level: 15%  
Upper Explosive Level: 28 %\*\*.



**Corrosive:** Avoid metals prone to stress corrosion cracking, e.g. zinc, copper, and brass. Use only compatible steel grades.



**Toxic:** Discomfort: 10 ppm, irreversible or serious long-lasting effects: 220 ppm for 30 min, potentially lethal: 2,700 ppm for 10 min\*.



**Low zero-carbon fuel\*\*:** However, NO<sub>x</sub> and N<sub>2</sub>O emissions and NH<sub>3</sub> slip are of concern.



**Other hazards:** Can cause burns due to alkalinity, hygroscopic nature, and low temperature.



**Liquid density:** 680 kg/m<sup>3</sup>, heavier than LNG



**Potentially harmful to aquatic life:**  
Discharges to sea should be avoided.



**Gaseous fuel:** Boiling temperature of -33°C at atmospheric pressure\*\*  
Vapor pressure of 18 bar at 45°C.



**Relatively low energy density:** Lower heating value: 18.8 GJ/t\*\*.

\* LR<sup>8</sup>

\*\*AEGL<sup>9</sup>

NO<sub>x</sub> = nitrogen oxides, N<sub>2</sub>O = nitrous oxide, NH<sub>3</sub> = ammonia, LNG = liquefied natural gas



**Mærsk Mc-Kinney Møller Center**  
for Zero Carbon Shipping

# 03

## Key design aspects

The toxic and gaseous nature of ammonia, along with its chemical and physical properties, poses new challenges for ship designs. This section provides a brief introduction to the main design elements for ammonia-fueled ships (see overview in Figure 3).

The specific design elements are discussed and analyzed in detail in Sections 4 to 8. One key design decision is the state in which the ammonia is stored on board (e.g., refrigerated vs. pressurized). This choice has a major impact on the scope of safety features and barriers required in the design phase.

Figure 3: Key design aspects of an ammonia-fueled ship and guide to relevant sections in this document.

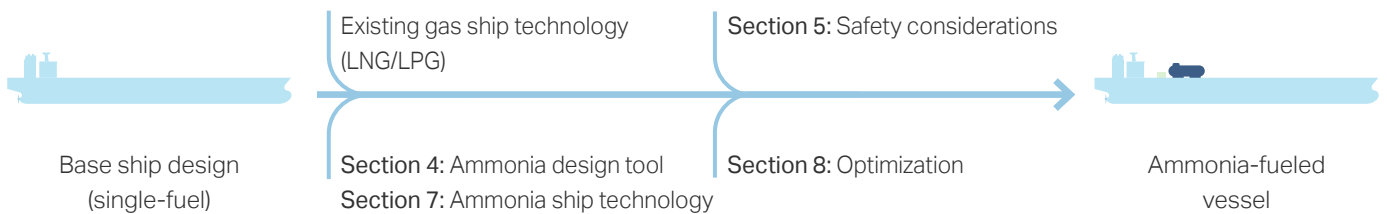

LNG = Liquefied natural gas, LPG = Liquefied petroleum gas





### 3.1 Safety measures

The toxicity and gaseous nature of ammonia are well known. Safety measures to prevent or minimize any release of ammonia are, therefore, necessary. For example, if, for some reason, the combustion of ammonia is not successful, the main engine operating mode will switch to fuel oil mode (gas trip), and an ammonia release management system (ARMS) will absorb purged ammonia gas. In addition, double-walled fuel piping with detection sensors must be installed as a countermeasure against ammonia leakage, as well as a vent mast for emergency discharge of ammonia gas to the atmosphere. Sections 5 and 6 explain the safety concept and related regulation in more detail.

### 3.2 Ammonia ship technology

The development of an ammonia dual-fuel engine is underway, and the first ship is scheduled for delivery in 2026. The main engine of the ammonia-fueled ship is a dual-fuel engine with the option of switching between operation on conventional fuel and ammonia fuel. A second fuel supply system/ammonia fuel supply system (SFSS/AFSS) supplies ammonia fuel to the main engine. This system prepares the fuel (pressure, temperature, filtration) before it is injected into the combustion chamber. We discuss the ammonia fuel main components in Section 7, while Section 8 delves into overall design optimization.

### 3.3 Design options and optimization

Table 1 provides an overview of selected marine fuels and their respective properties.

Liquid ammonia fuel stored at  $-33^{\circ}\text{C}$  requires 2.9 times the tank capacity of ultra low sulfur fuel oil (such as marine gas oil, MGO) to store the equivalent energy content.<sup>9</sup> Therefore, an ammonia-fueled vessel needs an independent tank for a large volume of low-temperature liquefied gas. For example, a mid-size ship with a 3,000 m<sup>3</sup> fuel oil tank capacity would require a liquid ammonia tank capacity of about 8,700 m<sup>3</sup> to meet the equivalent energy content.

The volume and weight increase associated with the required ammonia fuel impacts the ship design. It is necessary to define the required endurance for each project and to design the fuel arrangement for the specific ship type. This is illustrated in three schematic examples of different ammonia-fueled ships, where the endurance has been set to about 10,000 NM, which is less than half the range of a single-fueled ship. In these examples, we assume that the fuel system remains the same as in the case of oil (including tanks for several different types of fuel oil). Even for this endurance reduction, there are some design constraints to consider. One example is a reduction in cargo deadweight. If a longer range is required, an increase in the main dimensions of the ship or a further decrease in cargo should be considered – see also Section 8.

Table 1: Properties of marine fuels.

	Marine gas oil (MGO)	Liquid natural gas (LNG)	Methanol	Ammonia
Lower heating value (MJ/kg)	42.70*	48.00* **	19.90* **	18.80**
Liquid density (t/m <sup>3</sup> )	0.90*	0.45**	0.79* **	0.69**
Volume ratio per unit heating value vs. low-sulfur fuel oil (LSFO)	1.00	1.78**	2.44**	2.94**

\*As per MEPC.308(78)<sup>10</sup>

\*\*LR<sup>9</sup>

LNG density at atmospheric pressure  $-162^{\circ}\text{C}$ , ammonia density at atmospheric pressure  $-32^{\circ}\text{C}$ .



## 3.4 Examples of ammonia-fueled vessels

### 3.4.1. Bulk carrier

Figure 4 and Table 2 compare an ammonia-fueled Capesize bulk carrier with a conventional one. On bulk carriers, cylindrical fuel tanks are sometimes arranged behind or aside the accommodation so as not to obstruct the cargo handling. The size of the tank is therefore limited, and it may be necessary to reduce the range of the ammonia-fueled vessel.

Table 2: Comparison of particulars for an ammonia-fueled Capesize bulk carrier and a reference fuel oil equivalent (note that figures are approximations).

	Reference design - fuel oil (FO)	Ammonia-fueled
Main dimensions (LOA x B x D)	300 m x 50 m x 25 m	Same as base design
Cargo capacity	220,000 m <sup>3</sup>	Same as base design
Cargo deadweight loss	Base	-4,000 MT
Fuel oil tank capacity (endurance with FO)	4,000 m <sup>3</sup> (23,000 NM @ 13.5 kt)	2,000 m <sup>3</sup> (11,500 NM @ 13.5 kt)
Ammonia tank capacity (endurance with ammonia)	N/A	6,000 m <sup>3</sup> (3,000 m <sup>3</sup> x 2 tanks) (11,500 NM @ 13.5 kt)

LOA= length overall/overall length, B= breadth, D= depth, FO= fuel oil

Figure 4: Example of tank position on an ammonia-fueled Capesize bulk carrier.

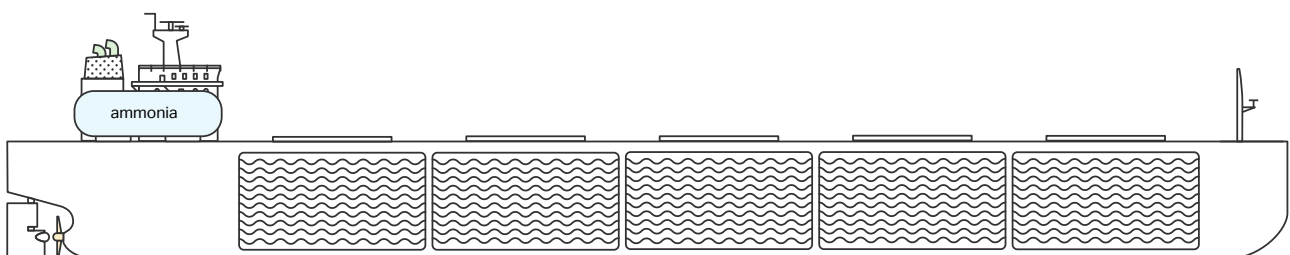

### 3.4.2. Oil tanker

Figure 5 and Table 3 show an example of a long-range (specifically, LR2) tanker converted to ammonia fuel. On tankers, it is common to arrange cylindrical tanks on the upper deck. Compared to a bulk carrier, it is easier to find the installation space for the fuel tank and to secure the endurance wanted. If a large tank is installed on the deck, it is also necessary to evaluate the bridge visibility, vessel stability, and hull longitudinal strength.

Table 3: Comparison of particulars for an ammonia-fueled LR2 tanker and a reference fuel oil equivalent (note that figures are approximations).

	Reference design - fuel oil (FO)	Ammonia-fueled
Main dimensions (LOA x B x D)	250 m x 44 m x 21 m	Same as base design
Cargo capacity	129,000 m <sup>3</sup>	Same as base design
Cargo deadweight loss	Base	-2,000 MT
Fuel oil tank capacity (endurance with FO)	2,700 m <sup>3</sup> (20,600 NM @ 13.5 kt)	1,350 m <sup>3</sup> (10,300 NM @ 13.5 kt)
Ammonia tank capacity (endurance with ammonia)	N/A	4,000 m <sup>3</sup> (2,000 m <sup>3</sup> x 2 tanks) (13,000 NM @ 13.5 kt)

LOA= length overall/overall length, B= breadth, D= depth, FO= fuel oil

Figure 5: Example of an ammonia-fueled LR2 tanker.

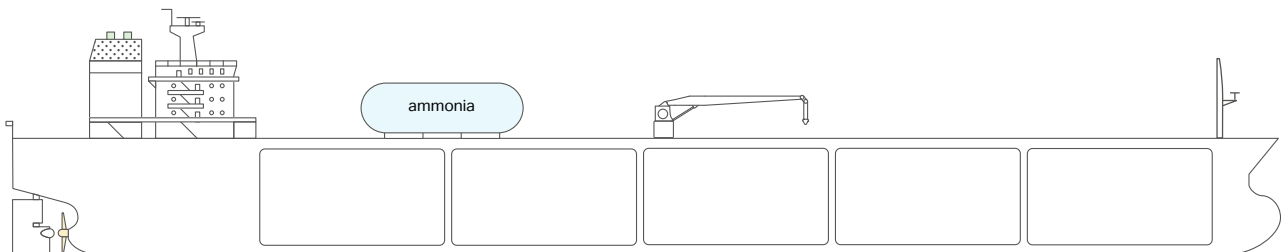

### 3.4.3 Container ship

Figure 6 and Table 4 show an example of a 15,000 TEU container ship. On large container ships, the fuel tank is generally installed in the space below the accommodation. To optimize the space used for fuel storage and to reduce the loss of cargo volume, a prismatic tank is normally used. Since the ship speed is higher than the average speed of other ship types and requires higher propulsion power, the fuel tank needs a large capacity, and a prismatic fuel tank is adopted in Table 4.

Table 4: Comparison of particulars for an ammonia-fueled 15,000 TEU container ship and a reference fuel oil equivalent.

	Reference design - fuel oil (FO)	Ammonia-fueled
Main dimensions (LOA x B x D)	356 m x 53.6 m x 30 m	Same as base design
Cargo capacity	15,700 TEU	Same as base design
Fuel oil tank capacity (endurance with FO)	8,200 m <sup>3</sup> (>24,000 NM @ 15 kt)	4,600 m <sup>3</sup> (>12,000 NM @ 15 kt)
Ammonia tank capacity (endurance with ammonia)	N/A	11,600 m <sup>3</sup> (>12,000 NM @ 15 kt)

LOA= length overall/overall length, B= breadth, D= depth, FO= fuel oil

Figure 6: Example of an ammonia-fueled 15,000 TEU container ship.<sup>1</sup>

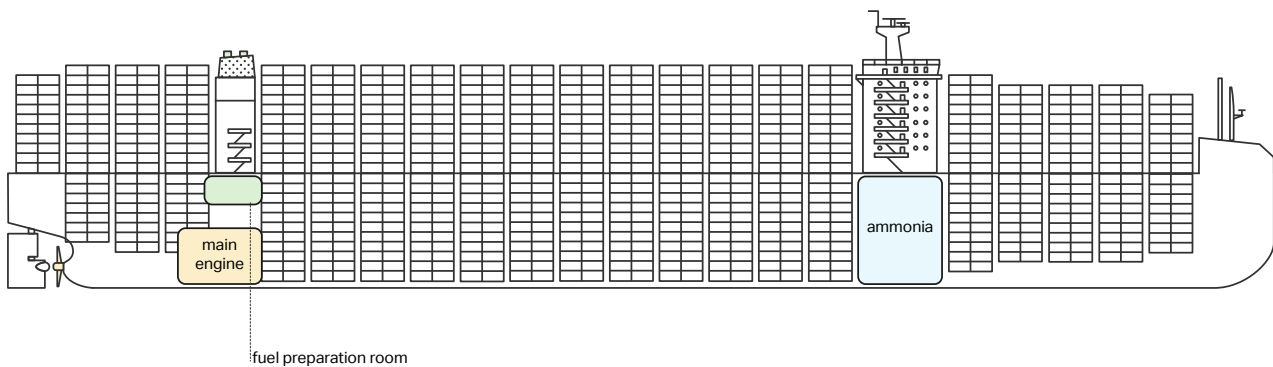

# 04

## Safety assessment tools during the design phase

Based on past projects conducted at the MMMCZCS, we used several tools to assess the safety level of ammonia-fueled ship designs and identify risks that the vessel can encounter throughout its lifespan. This assessment can result in a qualification plan with mitigative actions and identification of specific areas that need to be addressed in the design phase and early in the process to ensure sufficient time for design optimization.



### Hazard identification study (HAZID)

HAZID is a risk management tool that identifies potential hazards and their potential consequences. It is usually conducted in a workshop in which the technology is systemically assessed. Once the risks and their potential consequences have been identified, mitigative barriers and safeguards are proposed to minimize the likelihood and consequences of hazards.

Both HAZID and quantitative risk assessment (QRA) are often administered by a third party, e.g., the classification society and different parties such as the equipment maker, shipyard, and shipowner.

### Hazard and operability study (HAZOP)

HAZOP is a structured and systematic examination of a planned or existing process or operation to identify and evaluate problems that may represent risks to personnel or equipment or prevent efficient operation on board. Like the HAZID, the HAZOP is facilitated by a third party. A HAZOP can aid in the development of an operation manual and a contingency plan with options and recommendations for decision makers.

### Quantitative risk assessment (QRA)

As summarized in a report on ammonia safety previously published by the MMHCZCS and Lloyd's Register, QRA is "a powerful data-driven method that enables users to assess risk in a quantitative and granular manner which can be used to quantitatively estimate the effectiveness of risk mitigations by adding different modifications to the QRA model and observing their impact on the risk calculation."<sup>4</sup> Using a risk matrix, the QRA predominantly addresses the risk to people and the ancillary impact on the environment and business.

Once the risks have been identified and evaluated, preventive and mitigative measures are implemented to meet the proper safety level at an individual or social group level.

### Gas dispersion analysis and computational fluid dynamics

The International Maritime Organization's (IMO) guidelines for ammonia as fuel require a gas dispersion study in order to determine the extent of toxic area.<sup>11</sup> This is typically done using a computational fluid dynamics (CFD) analysis. It is recommended to assess different scenarios in the study. Attributes of scenarios usually include:

- Geometry of the ship
- Mass flow of ammonia gas
- Wind conditions (wind angle and apparent wind speed)
- Ambient air temperature
- Ambient air humidity (due to hygroscopic nature of ammonia gas)

If leakage scenarios are included in the assessment, the maximum probable leakage should be estimated.





# 05 Safety considerations

Although ammonia is already traded and shipped in large volumes, further technological development is needed before it will be widely accepted as a safe marine fuel. Safety aspects have been addressed in several studies and regulations, and the MMMCZCS is actively working together with its partners to address critical aspects such as crew safety and training, bunkering guidelines, technical solutions for inherently safer designs, and wider industry acceptance.



Leveraging the widespread industry adoption of LNG as a marine fuel provides practical technical solutions for handling refrigerated gaseous fuels. However, ammonia and LNG are different in terms of safety concepts. For LNG, the main risks relate to its flammability and cryogenic nature, whereas ammonia is more difficult to ignite, but is toxic. The primary focus regarding ammonia is, therefore, to protect the crew, shoreside personnel, and the environment from ammonia exposure.

Figure 7 gives an overview of the main hazards identified during the ammonia-fueled ship design projects at the MMMCZCS, and the pertinent countermeasures that can be applied at the design stage. These hazards include ammonia leakages, which pose a threat to both the crew and the environment, for example during bunkering. Leakages are particularly concerning if they occur in enclosed spaces such as in the FPR, or TCS.

The key protecting barriers identified from a ship design perspective are:

- Double-wall structures
- Appropriate location of the vent mast and ventilation inlet
- Implementation of alarms and automatic shutdown systems for bunker valves, tank valves, valves in the FPR, and master valves
- Automation and remote monitoring
- Water spray and containment system

Leakages should be directed to a location where they will not harm the crew and the environment. Furthermore, as an operational barrier, appropriate procedures must be in place with proper personal protective equipment (PPE).

Figure 7: Overview of onboard hazards and safety measures.

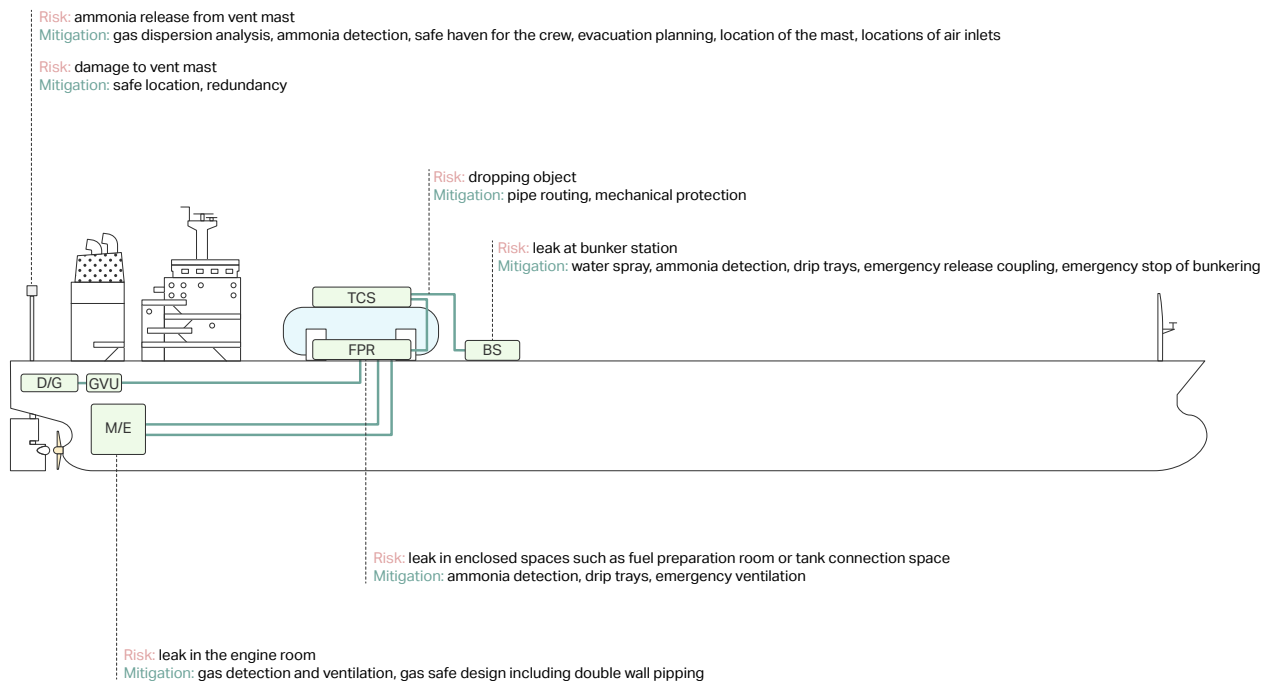

TCS= tank connection space, FPR= fuel preparation room, BS= bunker station, GVU= gas valve unit, D/G= diesel generator, M/E= main engine





## 5.1 General safety aspects for toxic areas

Even relatively small leakages of ammonia can form a dangerous concentration of ammonia gas when evaporating, especially in enclosed spaces.

Interim guidelines for ammonia as fuel introduce a toxic area and space classification,<sup>11</sup> which is a method of analyzing and classifying the areas where ammonia vapor may be expected to be present.

The following safeguards can be incorporated in the design to counter this danger:

- **Segregation**  
All ammonia-containing piping and equipment in enclosed spaces should be protected by a secondary enclosure to prevent mechanical damage. However, C-type tanks do not require a secondary barrier as the likelihood of a leakage is negligible.
- **Ergonomic safety**  
Special attention should be given to ensure safe and easy maintenance procedures, such as filter cleaning along with ease of access.
- **Emergency shutdown**  
Detection of high ammonia levels, pressure loss in piping, or other critical alarms should trigger a safe shutdown of the equipment and the flow of ammonia into the enclosed space. Detection of high ammonia leak levels, pressure loss in piping, or other critical alarms should trigger a safe shutdown of the equipment and the flow of ammonia into the enclosed space. The reaction time of the safety system can reduce the leaked quantities.
- **Automated operation**  
One of the most efficient means to reduce the risks is to reduce the time of exposure in the spaces containing ammonia equipment. This can be achieved by automating the operation and by separating the fuel supply equipment, e.g., main and auxiliary engines, in separate gas-tight rooms. Also, remote monitoring of the condition of equipment can reduce the need for visual inspection.

- **Remote monitoring**  
Remote operating panels, closed circuit television (CCTV), etc., reduce the necessary time spent in ammonia-containing spaces significantly.
- **Escape routes**  
There should be two escape routes for each space. Spaces below deck with access to a toxic area should be equipped with air locks.
- **Restricted access**  
Only competent and trained crew should be allowed to enter such spaces, and any activity to be governed by safety management processes and procedures outlining necessary steps and contingency planning to manage risks and avoid ammonia exposure. Visual indications that a space is safe to enter should be considered, for example red/green lamps.
- **Personal protective equipment (PPE)**  
Appropriate PPE should be made available and used, e.g., when carrying out maintenance.

## 5.2 Hazardous areas

The IGF code<sup>12</sup> defines hazardous areas as areas where an explosive gas atmosphere is or may be present. These areas are categorized as zone 0, 1, or 2 (Table 5). Areas containing other equipment besides the fuel system should be of a gas-safe design. In the engine room, ammonia should be led through double-walled piping, and all valves, filters, etc., should be installed inside ventilated gas-tight enclosures such as the gas valve unit (GVU).

Hazardous areas do not specifically address toxicity, unlike the definition of toxic areas.

Table 5: Classification of hazardous areas.

Zone 0	Interior of ammonia-containing equipment, such as piping and tanks.
Zone 1	TCS, FPR, bunker station, inter-barrier/hold space of Type A and B tanks.
Zone 2	Air locks and other entries to Zone 1.



### 5.3 Ventilation

The ventilation of the TCS and FPR must be in continuous operation and provided with effective extraction-type mechanically forced ventilation systems with a capacity of at least 30 air changes per hour. Ducts and double-walled fuel piping must be provided with the same ventilation capacity, i.e., at least 30 air changes per hour. An even higher emergency ventilation capacity and rate could also be required if ammonia gas is detected, to ensure it does not present a health hazard, according to respective class rules. In general, the ventilation fans must comply with the requirements for the respective hazardous area, but the classification societies have different requirements for redundancy of extractive ventilation.

It is important to reserve space for maintenance in machinery spaces. However, with an increased floor area and volume of these spaces, the emergency ventilation requirements could result in very large and power-consuming ventilation systems. This aspect should be considered in the design phase.

The ventilation exhaust ducts in the TCS and FPR, and vent outlets from double-walled fuel pipes, must lead to a safe location away from the nearest air intake, air outlet, or opening to other enclosed spaces on the vessel, and away from decks and gangways. Exact distances should adhere to the relevant rules and regulations, including the guidelines provided by the classification society.

Bunker stations not located on open deck must be suitably ventilated to prevent the accumulation of potential ammonia vapor releases inside the enclosed space.

### 5.4 Leak detection

It is a requirement, particularly for enclosed spaces, to measure the ammonia concentration of the ambient air. This can be achieved either in situ or by an extractive system, typically based on electrocatalytic or infrared measuring methods. Classification societies mandate at least two or three ammonia sensors per enclosed space. However, the total number of sensors should be determined based on the size, layout, and ventilation in the space. The position of the sensor must be given special attention as ammonia vapor can sink to the floor level due to its hygroscopic nature. Optimal sensor locations can be determined using a smoke test or simulation. All spaces with potential leak sources should have multiple ammonia sensors. Early detection and rapid response are crucial for effective mitigation. Emerging technology, capable of sensing ammonia concentrations as low as 1 ppm with both fixed and portable gas meters, combined with automation, is highly anticipated.



# 06

## Regulatory outlook

Currently, the International Code of Safety for Ships Using Gases or Other Low-flashpoint Fuels (IGF Code, Part A) does not cover the use of ammonia as fuel, and the International Code for the Construction and Equipment of Ships Carrying Liquefied Gases in Bulk (IGC Code) prohibits the use of toxic cargoes as fuel.<sup>12,13</sup>

However, the Maritime Safety Committee (MSC) under the IMO is currently amending both codes. It is expected that interim guidelines for the safety of ships using ammonia as fuel<sup>11</sup> will be approved at the MSC 109 taking place in late 2024.

Once approved, the IMO interim guidelines will provide an approval path for ammonia-fueled vessels. Designs other than those described in the interim guidelines may be approved through the guidelines for the approval of alternatives and equivalents, as provided in various IMO instruments, MSC.1/Circ. 1455<sup>14</sup>

At the time of writing, the development status of any national-level regulation in relation to the use of ammonia as fuel was not known.

In the absence of interim guidelines, several classification societies have developed their own requirements for ammonia-fueled ships. However, there are discrepancies among class rules which will be harmonized to respond to the interim guidelines. This document analyzes the remaining gaps between the current class regulations and interim guidelines.

Table 6: List of classification society rules analyzed.

Classification society	ABS <sup>15</sup>	BV <sup>16</sup>	CCS <sup>17</sup>	Class NK <sup>18</sup>	DNV <sup>19</sup>	LR <sup>20</sup>
Revision	2023	2022	2022	2024	2023	2022



The areas of class requirements in Table 7 were identified as being incoherent, having discrepancies, or not being clearly covered by the rules. Currently, the IGC Code for ammonia carriers and the class rules for ammonia fuel deviate from each other, e.g., in terms of ammonia releases to the atmosphere.

Appendix A elaborates further on the discrepancies and gaps listed.

The MMMCZCS has acknowledged this situation and is working with flag states, classification societies, and other stakeholders to shed light on remaining regulatory and standards challenges and areas that require an action plan for the industry.

Table 7: Development areas identified in rules and regulations.

Area	Discrepancy/gap identified in current rules and regulations
Ammonia exposure limits for humans	Alarm limits differ between classification societies, IACS UR (H1), and the IMO interim guidelines.
Ammonia emissions to air (statutory scope)	Emission limits differ between classification societies, IACS UR (H1), and the IMO interim guidelines.
Toxic zones	The concept of toxic areas is defined differently by the classification societies, IACS UR (H1), and the IMO interim guidelines.
Disposal of water containing ammonia	Currently, many classification societies prohibit any discharge of ammonia-contaminated water into the sea. In addition, it is currently not clear if ports will accept this type of waste product.
Gas freeing of ammonia tanks	Whereas the release of ammonia into the air is prohibited in normal operation, gas freeing before drydocking, for example, is not covered by most of the rules. If it is considered to be "normal operation", complying with ammonia emission limits, using the fuel system ammonia release management system may pose challenges.
Dispersion studies	A dispersion study may be required by e.g., the IMO interim guidelines, <sup>11</sup> but as there is no universally agreed methodology for a gas dispersion study, these studies may lead to inconsistent outcomes.
Fuel standard	There is no universally agreed fuel standard (e.g., ISO) for ammonia that defines fuel quality and allowable levels of e.g., impurities.

IACS = International Association of Classification Societies, IMO = International Maritime Organization, ISO = International Organization for Standardization



# 07

## Ammonia ship technology systems

Figures 8 and 9 show the main components of the ammonia fuel system and ship design. The following sections highlight the main design considerations, pertinent impact, and interconnection of various systems. Appendix B gives detailed descriptions of the system design for each of the technologies.

Figure 8: Schematic of document sections.

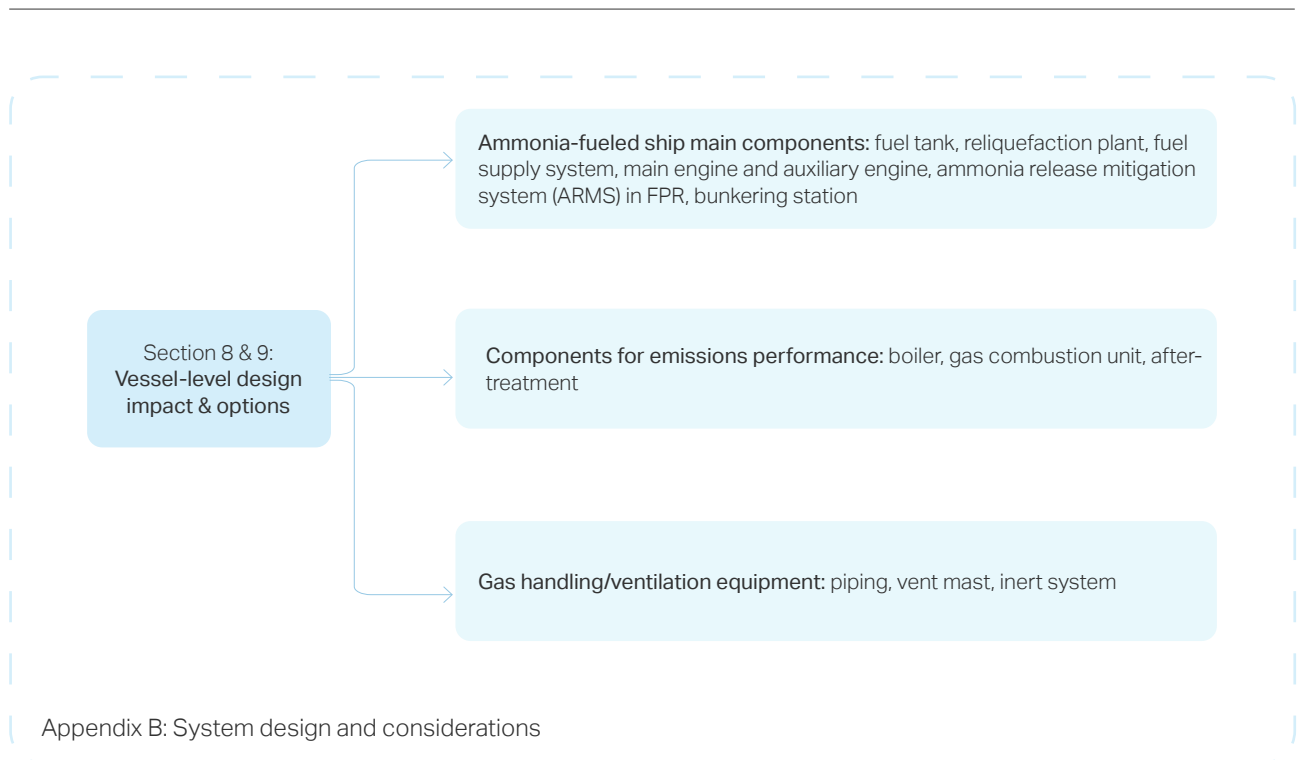

Figure 9 provides a pictorial representation of the components of an ammonia-fueled tanker. Normally, an ammonia-fueled ship design would include the following components and systems:

1. Ammonia fuel tank (containment system/storage)
2. Ammonia fuel supply system in TCS, FPR, and engine room (pump, heat exchanger, valves, filters, etc.)
3. Ammonia dual-fuel main engine and auxiliary engines
4. ARMS in FPR
5. Bunker station

Depending on ship design and type, the following components and systems may be included for optimization of the ammonia system regarding emissions performance:

- Ammonia reliquefaction plant
- Ammonia boiler
- Ammonia gas combustion unit
- After-treatment system

Also, special attention should be paid to the usual

components/structure/system for gas handling and ventilation, including:

- Piping for ammonia fuel system
- Vent mast
- Inert system
- Accommodation

The toxic and gaseous nature of ammonia and its low energy density create new ship design challenges, for example:

- Ammonia is usually stored in a refrigerated and/or pressurized state in independent insulated tanks.
- Leakage scenarios must be addressed .
- Manned areas must be protected against potential leakages.
- The accommodation area should provide a safe refuge for the crew. Many of the design alternatives affect other areas, and this complexity is described in Section 8. Additionally, Table 8 shows an overview of these relationships, which are further delineated in Section 8 and Appendix B.

Figure 9: Simplified schematic of an ammonia-fueled vessel.

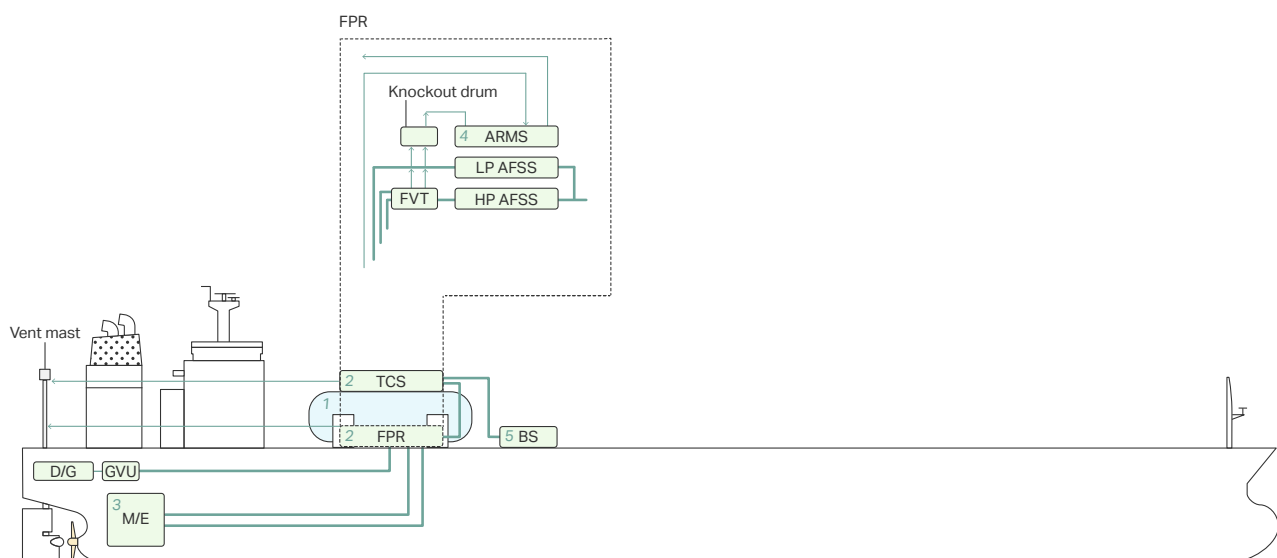

FPR= Fuel preparation room, ARMS= ammonia release management system , LP AFSS= low-pressure ammonia fuel supply system, HP AFSS= high-pressure ammonia fuel supply system, FVT= fuel valve train, TCS= tank connection space, BS= bunker station, D/G= diesel generator(s), GVU= gas valve unit, M/E= main engine



Table 8: Relationship between fuel system design and key performance indicators.

		Tank volume	Storage conditions	Tank type	Safety concept of FPR	Tank pressure (BOG) management	Ventilation from ammonia spaces	Drainage and bilge system	Selection of auxiliary system	Tank location	Bunker station (type/location)	Location of vent mast and ventilation outlets	Location of accommodation	Related key performance indicators
Fuel tank	Tank volume	-				◆				◆		◆	◆	Increased endurance for target
	Storage condition	◆	-	◆	◆	◆				◆				Safety (reduction of leakage)
	Tank type			-		◆				◆	◆	◆	◆	Cargo capacity (min. cargo loss)
System design	Safety concept of FPR				-		◆	◆	◆					Safety (reduction of exposure)
	Tank pressure (BOG) management	◆	◆	◆		-			◆					Fuel costs, safety (redundancy)
	Ventilation from ammonia spaces				◆		-	◆	◆			◆		Safety (reduction exposure)
	Drainage and bilge system				◆		◆	-						Safety (reduction exposure)
	Selection of auxiliary system				◆	◆	◆		-					CO <sub>2</sub> emission
Ship integration (arrangement)	Tank location	◆	◆	◆						-	◆	◆	◆	CapEx, minimize ship dimension
	Bunker station (type/location)			◆						◆	-	◆	◆	STS/terminal compatibility
	Location of vent mast and ventilation outlets	◆	◆	◆			◆			◆	◆	-	◆	Safety (reduction of exposure)
	Location of accommodation	◆	◆	◆						◆	◆	◆	-	Safety (reduction of exposure)

BOG= boil-off gas, CO<sub>2</sub>= carbon dioxide, CapEx= capital expenditure, STS= ship-to-ship

A comprehensive overview of the different components of the ammonia fuel system is provided in Appendix B.





# 08

## Vessel design options and considerations

Section 3 gives examples of ammonia-fueled ships with about 10,000-12,000 NM endurance (about half that of a conventional oil-fueled ship), considering utilization of a single-fuel base design. If longer endurance is needed, other vessel design options with different fuel tank types and locations should be considered. To optimize the design, various fuel system component options should also be considered.

In this section, we will elaborate more on the following areas:

- Fuel storage condition (refrigerated/pressurized)
- Type of fuel tank (cylindrical/prismatic) (Section 8.1)
- Position and volume of fuel tank (Section 8.2)
- Impact of endurance requirements on ship performance (Section 8.2)
- Fuel systems design considerations (Section 8.3)
- Accommodation and bridge location impact (Section 8.4)

Ammonia-fueled vessels can have different storage options: pressurization at normal temperature, semi-refrigeration or full refrigeration at atmospheric pressure. Fully pressurized storage is the simplest solution, using heavy C-type tanks designed for high vapor pressures, but they are limited in size, and heavy. Semi-refrigerated gas storage is more versatile and popular for smaller ships and uses tanks designed for moderate vapor pressures and low temperatures, accommodating a range of gases. Finally, fully refrigerated storage, which is ideal for large quantities of ammonia, uses tanks designed (refer to Table 9) for atmospheric pressure and requires comprehensive safety measures, offering the lowest risk in case of a leak.<sup>4</sup>

It should be noted that per the IMO interim guidelines,<sup>11</sup> ammonia should be stored at atmospheric pressure (i.e., fully refrigerated). Thus, applying a fully-pressurized or semi-pressurized tank design requires alternative design approval through MSC.1/Circ. 1455.<sup>14</sup>





## 8.1 Fuel tank options

Tank type considerations are essential when considering optimization of tank type, volume, and location during the design phase.

Tables 9 and 10 compare the tank types compatible with ammonia designs. Both cylindrical and prismatic tanks can be used for ammonia fuel storage. Their reliability is supported by the service results from liquefied petroleum gas (LPG)/ammonia carriers obtained over many years. In general, depending on the storage condition, a cylindrical tank is suitable for on-deck installation, and a prismatic tank is suitable for cargo space installations. One reason is that a prismatic tank (IMO Type A or B) requires a secondary barrier (surrounding structure), whereas a cylindrical tank (IMO Type C) does not.

IMO has established safety regulations for gas carriers and gas-fueled ships, and cylindrical tanks are classified as Type C.<sup>21</sup> For Type C tanks, the secondary barrier (barrier outside the tank to stop any liquefied gas leakage) is exempted because the risk of fatigue failure is low thanks to the high static internal pressure of the tank structure. On the other hand, the maximum volume of cylindrical tanks is restricted by the plate thickness limitations due to high internal stress.

From the viewpoint of volume efficiency, a prismatic tank is more advantageous than a cylindrical tank when a long operating range is warranted. This is due to its shape and low design pressure. Prismatic tanks correspond to either Type A or Type B under the IMO IGC/IGF Codes.<sup>12,22</sup> For a Type A tank, a full secondary barrier is required. For a Type B tank, a partial secondary barrier is allowed if an advanced analysis technique is applied, and if both tank reliability and design flexibility can be ensured.

Table 9: Fuel tank types.w

	Cylindrical	Prismatic	
Tank type	Pressurized at ambient temperature or lower temperature	Fully refrigerated at nearly atmospheric pressure	
Tank shape/structure			
	Source: MHI	Source: MHI	
IMO tank type	Type C	Type A	Type B
Secondary barrier	Not required	Full	Partial



Table 10: Secondary barrier options for prismatic tanks.

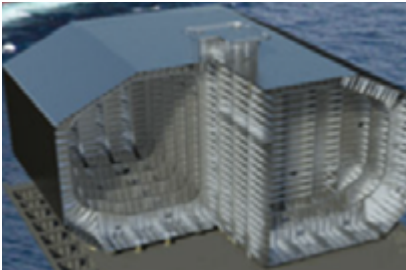
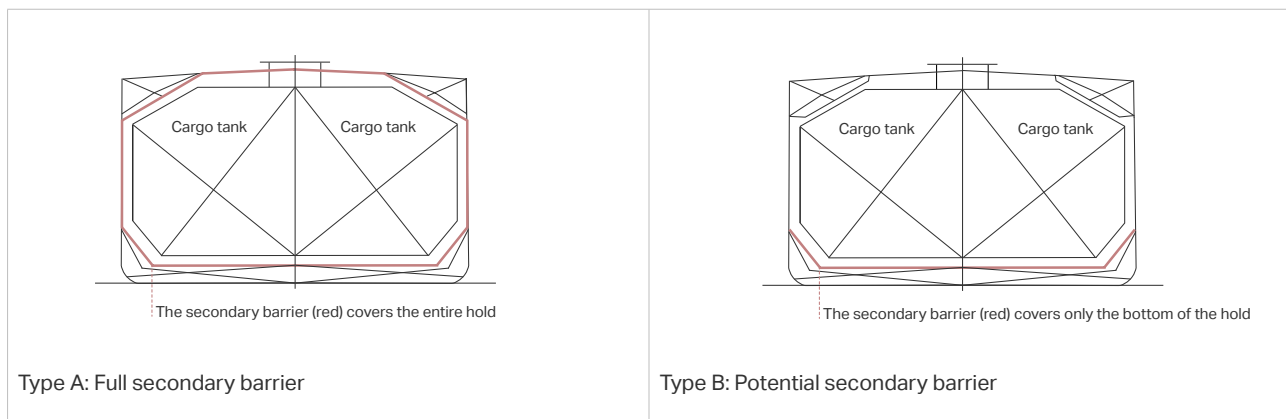

In addition to the shape and necessity of a secondary barrier, the concept of tank pressure control is also important when considering an optimization of the fuel tank arrangement. The IMO interim guidelines do not allow a direct tank pressure release into the atmosphere, except in the case of an emergency. Unless fully pressurized storage (C-type tank) is applied, the ammonia fuel system should have redundant means to maintain the tank pressure below the pressure release valve set point. Also, tank insulation requires attention. A well-insulated tank reduces the need for an active pressure management system.

Typically, active pressure management alternatives comprise the following:

- **Reliquefaction:** Evaporated ammonia is compressed and cooled/condensed into a liquid state before being returned to the storage tank. This is a typical design approach for non-pressurized storage tanks.
- **Subcooling of liquefied gas:** Pressurized liquid ammonia is kept below the boiling point by heat exchangers utilizing a refrigerant. This approach can be used in combination with semi-refrigerated and fully refrigerated C-type tanks.
- **Combustion:** Thermal oxidation of ammonia vapor in a gas combustion unit or an ammonia-fired boiler. Applicable for all storage types, but the recovery of energy can be challenging.

Some classification societies consider fully pressurized storage tanks as an option, while others require other options, e.g., a 30-day holding time minimum.

## 8.2 Fuel tank arrangements

### 8.2.1. Options for tankers and bulk carriers

First, we discuss the possible tank arrangements with either a cylindrical or a prismatic fuel tank for both an oil tanker (Table 11) and a bulk carrier (Table 12).

When planning the design of an ammonia-fueled ship, the base design of a single-fueled ship and on-deck tanks is a good starting point. This approach is termed O1 for an oil tanker in Table 11, and B1 for a bulk carrier in Table 12. For such on-deck tank solutions, the following should be considered:

- 1. Space for fuel tank installation:** Limited tank volume due to deck space restrictions. For a bulk carrier, only the aft part can be used.
- 2. Visibility from navigation bridge:** For the O1 arrangement, the visibility from the navigation bridge should be checked.
- 3. Stability:** Rechecking the ship's stability may be necessary, depending on the margin of the base design.
- 4. Hull longitudinal strength:** It may be necessary to consider the increased still water bending moment.
- 5. Impact on ship performance:** The endurance of O1 and B1 type designs should be decided considering the above points for each ship design.
- 6. Exposure of the tank to other hazards:** Fire, dropped objects.



Table 11: Tank type and position alternatives for an oil tanker.



Case	O1	O2
Tank location	Cargo deck	Cargo hold
Tank shape	Cylindrical	Prismatic
Tank type	IMO IGC Code Type C	IMO IGC Code Type A/B
Schematic figure		
Design issues	<p><i>Advantage</i></p> <ul style="list-style-type: none"> <li>- Utilization of hull form of single-fueled ship</li> </ul> <p><i>Points to pay attention to</i></p> <ul style="list-style-type: none"> <li>- Cargo deadweight loss</li> <li>- Impact on performance</li> <li>- Visibility from navigation bridge</li> <li>- Stability of hull</li> <li>- Hull longitudinal strength</li> <li>- Interaction with on-deck cargo arrangement</li> <li>- Exposure of the fuel tank to other hazards (e.g., cargo tank explosion)</li> </ul>	<p><i>Advantage</i></p> <ul style="list-style-type: none"> <li>- Custom-made design for target performance</li> </ul> <p><i>Points to pay attention to</i></p> <ul style="list-style-type: none"> <li>- Cargo deadweight &amp; volume loss</li> <li>- Redesign of hull form and ship arrangement</li> <li>- Increased overall dimension</li> <li>- Terminal compatibility</li> <li>- Reliquefaction plant</li> <li>- Exposure of the tank to other hazards (e.g., collision, grounding)</li> </ul>

Table 12: Tank type and position alternatives for a bulk carrier.

Case	B1	B2
Tank location	Aft deck	Cargo hold
Tank shape	Cylindrical	Prismatic
Tank type	IMO IGC Code Type C	IMO IGC Code Type A/B
Schematic figure		
Design issues	<p><i>Advantage</i></p> <ul style="list-style-type: none"> <li>- Utilization of hull form of single-fueled ship</li> </ul> <p><i>Points to pay attention to</i></p> <ul style="list-style-type: none"> <li>- Exposure to collision</li> <li>- Cargo deadweight loss</li> <li>- Impact on performance</li> <li>- Limitation of tank capacity (endurance)</li> <li>- Stability of hull</li> <li>- Hull longitudinal strength</li> <li>- Outlet of ventilation from ammonia spaces</li> </ul>	<p><i>Advantage</i></p> <ul style="list-style-type: none"> <li>- Custom-made design for target performance</li> </ul> <p><i>Points to pay attention to</i></p> <ul style="list-style-type: none"> <li>- Cargo deadweight and volume loss</li> <li>- Redesign of hull form and ship arrangement</li> <li>- Increased overall dimension</li> <li>- Terminal compatibility</li> <li>- Reliquefaction plant</li> <li>- Exposure of the tank to other hazards (e.g., collision, grounding)</li> <li>- Outlet of ventilation from ammonia spaces</li> </ul>

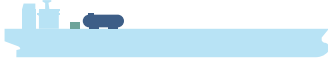
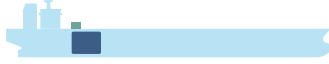

When the hull form of a base single-fuel ship design is applied (O1 for oil tanker and B1 for bulk carrier), the increased ship weight resulting from the ammonia conversion (additional weight of ammonia fuel system and ammonia fuel) affects its performance depending on the required endurance. For the increased ship weight with the same draft, it is necessary to either decrease the cargo deadweight or increase the underwater volume of the hull form, which impacts the performance negatively.

The MMMCZCS has carried out a series of case studies investigating these two possibilities (decrease cargo deadweight or change the hull form), with the results shown in the column marked original (FO) in Tables 13 and 14. It should be noted that the numbers in the tables are based on specific ship designs and may change depending on the baseline designs. However, it is beneficial to understand the tradeoff between endurance and performance when considering a ship specification for an individual project.

The following three cases have been investigated for an O1 type Very Large Crude Carrier (VLCC) and a B1 type Capesize bulk carrier.

- **Case 1** Sacrificing cargo deadweight: Loss of cargo deadweight with retained fuel oil consumption (FOC) and speed.
- **Case 2** Sacrificing fuel consumption: Deterioration of fuel consumption with retained cargo deadweight and speed.
- **Case 3** Sacrificing ship speed: Loss of ship speed with retained cargo deadweight and fuel consumption.

All values for ammonia in Tables 13 and 14 are stated as a ratio (percentage) of the base parameter for the original single-fueled ship.

When evaluating the impact of decreased cargo deadweight in Case 1, the fuel consumption and speed are fixed at their original values. The evaluations made for Cases 2 and 3 will follow the same principle. In Cases 2 and 3, the hull form was modified to provide additional displacement for the increased weight of the ammonia fuel system and ammonia fuel. As a result, the ship has a blunter underwater hull form, which causes deterioration of the ship's propulsion performance. We calculated the weight increase and completed basic naval architectural checks for longitudinal strength, stability, and resistance.

To compare the impact the endurance has on the results of the case studies, we estimated the impacts separately for each target endurance for a VLCC, i.e., 20,000 NM, 15,000 NM, and 10,000 NM endurance.

On a Capesize bulk carrier, the tanks must be arranged on deck alongside or aft of the accommodation because of the cargo hold hatches on deck. This results in a significant increase in the hogging moment. Additionally, the space around the accommodation is restricted and, therefore, it was not feasible to arrange tanks suitable for 20,000 NM.

If the endurance obtained with an on-deck tank design (O1/B1) does not satisfy the requirements of a project, or the ship performance deterioration is unacceptable, a prismatic tank solution and a new hull form should be considered. This solution is shown as O2 for an oil tanker in Table 11 and B2 for a bulk carrier in Table 12. For this prismatic tank solution, the following should be considered:

- Redesign of hull form and ship arrangement.
- Cargo loss: If additional tanks are installed in the main hull and the ship dimensions are unchanged, the cargo loss will be substantial.
- Increased overall dimensions: If the above cargo loss is unacceptable, the overall dimensions should be increased.
- Terminal compatibility: Should be considered with increased ship dimensions.
- Reliquefaction plant: The prismatic tank should be fully refrigerated and therefore requires reliquefaction.

In conclusion, the relationship between the location of the tank and other systems (such as bunker stations, ventilation outlets and inlets) should be evaluated in all cases. In the detailed design stage, the locations should be chosen with consideration for the safety of the crew. Also, ammonia fuel pipe routing and protection should be considered.



Table 13: Result of the impact study for a VLCC (ammonia values are compared to the original FO base design and stated in percentages).

Fuel type	Original (FO)	Ammonia dual-fuel ship		
Endurance	20,000 NM	10,000 NM	10,000 NM	10,000 NM
Endurance (ammonia)	N/A	20,000 NM	15,000 NM	10,000 NM
Case 1: Cargo dwt adjusted (FOC & speed kept same)	Base	4.1% DWT loss	2.8% DWT loss	1.2% DWT loss
Case 2: FOC adjusted (cargo DWT & speed kept same)	Base	4.1% FOC increase	4.0% FOC increase	2.2% FOC increase
Case 3: Service speed adjusted (cargo DWT & FOC kept same)	Base	1.9% speed loss	1.2% speed loss	0.7% speed loss

FO = fuel oil, DWT = deadweight tonnage, FOC = fuel oil consumption

Table 14: Result of the impact study for a capesize bulk carrier (ammonia values are compared to the original FO base design and stated in percentages).

Fuel type	Original (FO)	Ammonia dual-fuel ship	
Endurance	24,000 NM	12,000 NM	12,000 NM
Endurance (ammonia)	N/A	10,000 NM	5,000 NM
Case 1: Cargo dwt adjusted (FOC & speed kept same)	Base	2.4% DWT loss	0.6% DWT loss
Case 2: FOC adjusted (cargo DWT & speed kept same)	Base	4.0% FOC increase	1.4% FOC increase
Case 3: Service speed adjusted (cargo DWT & FOC kept same)	Base	1.4% speed loss	0.5% speed loss

FO = fuel oil, DWT = deadweight tonnage, FOC = fuel oil consumption



### 8.2.2. Options for container ships

Table 15: Tank type and position alternatives for a container ship.

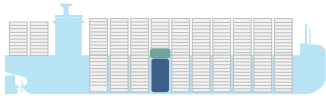
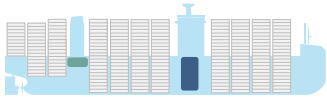
Case	C1: Single or twin island design	C2: Twin island design
Tank location	Cargo hold	Under accommodation
Tank shape	Prismatic or bilobed/cylindrical	Prismatic or bilobed/cylindrical
Tank type	IMO IGC Code Type A, B or C	IMO IGC Code Type A, B or C
Schematic figure		
Design issues	<p><i>Advantage</i></p> <ul style="list-style-type: none"> <li>- Possible to optimize tank and bunker station location to suit large bunker vessels and create distance to accommodation.</li> </ul> <p><i>Points to pay attention to</i></p> <ul style="list-style-type: none"> <li>- Minimize fuel pipe length: tank to fuel supply system, and fuel supply system to engines.</li> <li>- Fuel piping protected in the event of ship collision.</li> <li>- Distance from tank to ship side and bottom.</li> <li>- Minimize distance from TCS to vent mast.</li> <li>- Exposure of the tank to other hazards (eg., collision, grounding).</li> <li>- Outlet of ventilation from ammonia spaces</li> <li>- Impact on cargo capacity and range on ammonia.</li> </ul>	<p><i>Advantage</i></p> <ul style="list-style-type: none"> <li>- Space under accommodation used for fuel storage.</li> </ul> <p><i>Points to pay attention to</i></p> <ul style="list-style-type: none"> <li>- Distance from tank to ship side and bottom.</li> <li>- Safe distance from bunker station to accommodation.</li> <li>- Location of FPR near the engine room. Short high-pressure fuel piping to engines.</li> <li>- Fuel piping protected in the event of a ship collision.</li> <li>- Need for separate refuge for crew members working towards the stern.</li> <li>- Exposure of the tank to other hazards (eg., collision, grounding).</li> <li>- Outlet of ventilation from ammonia spaces.</li> <li>- Impact on cargo capacity and range on ammonia.</li> </ul>

## 8.3. Fuel system design options

Ship designers can create a safer and more efficient environment by evaluating factors such as the distance from crew accommodation to vent masts, protective measures against physical hazards, and accessibility during maintenance and emergencies. The integration of advanced monitoring technologies further supports these goals by enabling effective management of space with minimal direct human intervention. The calculation of total cost of ownership (TCO) (i.e., fuel costs + OpEx + CapEx) caters for an informed cost calculation and decision-making during the ship design process.

Table 16 provides an overview of different optimization options and the design objective with pertinent considerations for the primary systems on board. Further details are provided in Appendix B.



Table 16: Options for fuel system design.

System	Design options	Design objective	Key considerations
Safety concept of FPR (ammonia reliquefaction)	<p>Placement close to engine room to reduce the length of high-pressure fuel pipes.</p> <p>No access from accommodation to the FPR, and double barrier between FPR and accommodation.</p> <p>Division of space (i.e., separation of main and aux. supply systems) and location to ensure protection from cargo fire and dropped objects.</p>	Designed for safety, accessibility and escape options.	Adequate protection and remote control and monitoring to reduce the time of exposure inside the room.
Tank pressure management – BOG	<p>For fully or semi-refrigerated tanks:</p> <ul style="list-style-type: none"> <li>– Reliquefaction system to recondense vapor.</li> <li>– Subcooling and top spray system to cool the tank and keep pressure.</li> <li>– Pressure accumulation, combined with consumption of tank content (pressurized tank, Type C).</li> <li>– Combustion: Gas combustion unit, ammonia combustion in boiler.</li> </ul>	Designed for keeping normal tank pressure continuously.	<p>Consideration of boiler/ burner for reduced number of reliquefaction plants which will reduce costs.</p> <p>During bunkering: consideration of vapor return line for tank control.</p> <p>Redundancy as required by the class/IGF Code.</p>
Bunker station	<p>Location: Midship/aft end of cargo area.</p> <p>Type: Open/semi-closed/fully enclosed to reduce/control ammonia gas dispersion.</p>	Designed for compatibility with bunkering vessels and flexibility in operations.	<p>Length of piping. Shorter piping leads to increased safety and reduced costs.</p> <p>Consideration of safe distance from accommodation.</p> <p>Space arrangement for safe hose handling and passage.</p>
Ventilation from ammonia spaces	<p>Ventilation options for, e.g., TCS, FPR and secondary barrier:</p> <ul style="list-style-type: none"> <li>– Vent directly to air from exhaust fan outlet.</li> <li>– Ventilation exhaust fan to be led to vent mast or outlet led to safe space for crew spaces.</li> </ul>	<p>Outlets lead to a safe location.</p> <p>Optimal ventilation arrangement with independent and redundant systems design.</p>	<p>Room geometry should be designed to avoid air pockets, in which gas could accumulate.</p> <p>Ventilation rate design as per the class guidelines.</p>

TCS=tank connection space, FPR=fuel preparation room, BOG= boil-off gas, ARMS= ammonia release mitigation system, GCU= gas combustion unit, IMO= International Maritime Organization, CapEx= capital expenditure, and OpEx=operating expenses



Ammonia release management system (ARMS)	<p>To comply with ammonia emission limits for air, the following solutions could be considered:</p> <ul style="list-style-type: none"> <li>– Absorption to water e.g., water seal or wet scrubber.</li> <li>– Combustion, e.g., GCU or boiler.</li> <li>– Adsorption, e.g., activated carbon filters.</li> <li>– Dilution to acceptable ppm levels.</li> </ul>	Highest ammonia abatement efficiency.	<p>Volumetric and mass flow of ammonia vapor.</p> <p>Handling of residues, e.g., ammonia-contaminated water.</p> <p>Abatement efficiency.</p> <p>Reliability.</p> <p>OpEx.</p>
Location and number of vent masts and ventilation outlets	<ul style="list-style-type: none"> <li>– One or multiple independent vent masts to release pressure from fuel storage tanks in an emergency.</li> <li>– One or multiple independent ventilation outlets from semi-enclosed bunker stations, TCS, reliquefaction plant and main engine, and auxiliary engine FPR. Individual ventilation ducts can be combined in a common mast/riser.</li> </ul>	Designed for minimized risk of leaks and for dispersion far from accommodation.	<p>Minimization of downstream pressure loss to vent mast.</p> <p>Ship arrangement, considering all foreseeable potential leak points.</p> <p>Identification of credible foreseeable release conditions.</p>
Steam/heat production onboard	<p>While fuel oil may not require heating, especially on tankers, cargo might require substantial heating on tankers.</p> <p>Hot water and especially steam could be produced by means of:</p> <ul style="list-style-type: none"> <li>– Conventional oil-fired boilers.</li> <li>– Ammonia-fired boilers.</li> <li>– Electric boilers.</li> <li>– Exhaust gas boilers (NB: in winter conditions, exhaust gas temperature from ammonia main engine might not be enough to produce enough high-pressure steam).</li> </ul>	Designed for efficient performance on ammonia as a fuel.	<p>Auxiliary systems come with increased complexity and costs as an additional fuel supply system is required.</p> <p>Power production with respect to:</p> <ul style="list-style-type: none"> <li>– CO<sub>2</sub> emissions</li> <li>– CapEx</li> <li>– Fuel efficiency</li> </ul>
Drain and bilge	<p>Collect and store drainage from toxic areas onboard or treat it as bilge. Options:</p> <ul style="list-style-type: none"> <li>– Ammonia water bilge drain tank to contain drain from ARMS and water/ammonia collection.</li> <li>– Liquid ammonia drain tank to contain drained ammonia in case of larger spills.</li> </ul>	Drain piping and drip trays are dimensioned to handle maximum credible leak scenario.	<p>Location of the drain tank vent outlets.</p> <p>Check with the authorities (flag administrations and/or IMO) if it is permissible to discharge overboard treated bilge that potentially contains ammonia. If treated water is stored onboard, check with ports to see if they accept this type of waste.</p>





## 8.4 Accommodation location and bridge design

### 8.4.1 Location of accommodation

As shown in 8.2.2, the accommodation structure on a large container ship (for example, larger than 15,000 TEU) is usually located on the fore end of the vessel.

On conventionally designed smaller container ships, bulk carriers, and oil tankers, the accommodation structure is located on the aft part of the vessel. Non-conventional designs with fore-end accommodation are considered for ammonia-fueled ships as a countermeasure against gas dispersion, to keep a safe distance from gas.

Aft accommodation and fore-end accommodation designs were compared in the NoGAPS2 project for an ammonia-fueled ammonia carrier.<sup>3</sup> Based on the results of this project, these two options are compared in Table 17 for tanker and bulk carrier applications.

Generally, all accommodation air intakes should be located as far away as possible from the ammonia system ventilation outlets and other potential sources of ammonia leakage (e.g., at the bunker station). The distance between vent mast and air inlet of the ventilation system must comply with the pertinent rule requirements. Some rules specify an air intake design with an automatic closing damper. For example, according to LR and DNV, all air intakes must be fitted with permanent gas detection sensors. according to risk assessment.<sup>19, 20</sup>

Vent mast and ventilation outlets should be located as far away as possible from the accommodation, so that in a worst-case scenario, the ship could be maneuvered in such a way that the ammonia release plume is led away from the accommodation and muster station.

The accommodation air-handling unit could be switched to 100% recirculation ventilation during bunkering and if a leakage is detected. Over-pressurization would further protect the accommodation from potentially toxic releases, and so function as a safe haven for the crew. Over-pressurization requires replacement air that can be supplied from a safe location (which must be free of ammonia gas according to the gas dispersion study).

Table 17: Considerations regarding the location of accommodation on tankers and bulk carriers.

Viewpoint	Traditional aft accommodation	Fore-end accommodation
Ship integration	Standard ship design. Minimized ship dimensions for same cargo capacity. Simplest and cheapest accommodation arrangement.	Complex ship design. High CapEx. Ship length increased with same cargo capacity due to inefficient space utility under accommodation. Additional electric cable connections to aft engine room necessary. Duplication of rooms fore and aft.
Crew comfort	Average crew comfort (ship motion).	Lower crew comfort in rough seas. Speed reduction may be necessary if the ship motion exceeds the limit.
Leak from fuel tank	Shorter distance from tank.	Longer distance from tank.
Venting from ammonia fuel tank	It is possible to keep a distance between accommodation and vent mast?	It is possible to keep a distance between accommodation and vent mast?
Leak in FPR/TCS	Ventilation outlet is closer to accommodation. The outlet may need to be led to a vent mast.	Longer distance between ventilation outlet and accommodation.
Lifesaving	Safe and easy access to lifeboats for all crew groups.	If possible, minimize the distance between accommodation and muster station/lifeboat.

FPR= fuel preparation room, TCS= tank connection space, CapEx= capital expenditure



### 8.4.2. Bridge design

Table 18 provides an overview of the bridge design options in pursuit of the elevated safety standards listed in Table 17.

Table 18: Options for bridge design.

System	Design options	Design objective	Key consideration
Bridge design in the context of ammonia as a fuel	<p>Option to equip bridge with separate ventilation and gas filtration.</p> <p>Additional internal passage, protected with water spray, leading to the assembly station.</p> <p>Enclosed bridge wing.</p>	Designed as a "safe haven" with limited exposure to dispersion.	Mitigation of the risk of exposure to gas leaked outside. Escape of crew and evacuation to "safe haven".



# 09

## Conclusion

Ammonia is a potential low-GHG-intensity fuel for maritime applications. However, safety concerns surrounding ammonia are paramount and must be addressed through clear regulations, best practices, and ship designs that mitigate the risks. The MMMCZCS has previously reported various results from research on ammonia-fueled ships, aiming to improve understanding and facilitate the adoption of ammonia as a marine fuel. Drawing on the knowledge gained from these studies, this publication serves as a guide for readers considering ammonia-fueled ships.

The safety of crew and shoreside personnel is the guiding principle of this publication, introducing safeguards and design considerations (Section 5), and tools to manage and mitigate risks (Section 4) applying the inherently safer design principle. To assess the safety of ammonia-fueled ship designs, identifying risks and creating mitigation plans is imperative early in the ship design process. QRA and gas dispersion analyses address potential ammonia gas leaks. Ensuring crew safety involves implementing safeguards like double-wall structures, emergency shutdown systems, remote monitoring, and proper PPE.

This publication also identifies some regulatory gaps and variations regarding ammonia-fueled ships (Section 7 and Appendix A). In collaboration with our partners, the MMMCZCS has actively supported the work of IMO's Maritime Safety Committee to ensure that the 2024 interim guidelines for ammonia provide clarity.

In addition to safety challenges, the relatively low energy density of ammonia presents challenges for ship design. Most designs for ammonia dual-fuel vessels are unlikely to achieve the same endurance as those using fuel oil without increasing ship dimensions or sacrificing cargo capacity. The targeted endurance will dictate the dimensions and location of storage tanks. For tankers and bulk carriers, these will likely be cylindrical tanks on deck, while for container ships, the design will vary depending on vessel size.

A safe ammonia-fueled vessel design can be achieved by incorporating ammonia-specific fuel technology into traditional gas-fueled vessel technology. The storage condition, type and location of storage tanks will dictate the rest of the equipment layout. With the help of risk assessment tools and gas dispersion studies, the optimal locations for vent outlets, vent masts, air intakes, and other system components (e.g., bunker stations) can be defined. Section 4 introduces safety-related tools, while Section 8 and Appendix B address ship and system design alternatives.

We leverage our modular knowledge from industry collaborations with leading stakeholders to provide objective recommendations on risk assessments, safety criteria, and ship design integration for ammonia-fueled vessels. This publication aims to help readers build confidence in designing ammonia fueled designs with guidance and practical examples, thereby contributing to shipping's transition towards low-GHG-intensity fuels.



# 10

## The project team

This document was prepared by the Mærsk Mc-Kinney Møller Center for Zero Carbon Shipping (MMMCZCS) with assistance from our partners. Team members marked with an asterisk (\*) were seconded to the MMCZCS from their home organizations.

---

**Lead author:** Georgios Atzamos (MMMCZCS).

**Contributing authors and project participants:** Georgios Atzamos (MMMCZCS), Pekka Pohjanen\* (Seaspan), Koichi Sato\* (Mitsubishi Heavy Industries), Claus Rud Hansen\* (Maersk), Satoshi Ando\* (Mitsubishi Heavy Industries), Miu Hatamura (Tsuneishi), Jun Ito\* (NYK Line), Wijnand Bodewes\* (Stolt Tankers).

**Reviewers:** Björn Ola Stråby (Maersk), Peter Nerenst (MAN ES), Seb Brindley\* (Seaspan), Hiroyuki Uchibori\* (Tsuneishi), Vangelis Karageorgos (ABS), Alexandros Katsinos (ABS), Liam Blackmore (Lloyd's Register), Andy Franks (Lloyd's Register), Martin Eriksen (MMMCZCS), Shinichi Iwamoto\* (NYK Line), Robert Bridges\* (TotalEnergies).

**Project steering committee:** Claus Graugaard † (MMMCZCS), Emiliano Austi (Maersk), Estela Vázquez Esmerode (MMMCZCS), Evangelos Fragkoulis (MMMCZCS), Joshua Scott McMinn (Maersk), Rene Laursen (ABS), Peter Abildgaard (Lloyd's Register).

**Editors:** Jacob Bonelli\* (MAN ES), Kit Drescher Jernshøj\* (MAN ES), Annette Asante Jakobsen\* (MAN ES), Matilda Handsley-Davis (MMMCZCS).

**Design:** Julia Garbowska (MMMCZCS).



# Abbreviations

<b>Abbreviation</b>	<b>Full form</b>
ABV	Ammonia bunker vessel
AFSS	Ammonia fuel supply system
ARMS	Ammonia release mitigation system
B	Breadth
BOG	Boil-off gas
BS	Bunker station
CapEx	Capital expenditure
CCTV	Closed circuit television
CFD	Computational fluid dynamics
CO <sub>2</sub>	Carbon dioxide
D	Depth
DF	Dual-fuel
D/G	Diesel generator
DWT	Deadweight tonnage
ERC	Emergency release coupling
ESD	Emergency shutdown
FO	Fuel oil
FOC	Fuel oil consumption
FPR	Fuel preparation room
FVT	Fuel valve train
GCU	Gas combustion unit
GHG	Greenhouse gas
GVU	Gas valve unit
HAZID	Hazard identification study
HAZOP	Hazard and operability study



HP AFSS	High-pressure ammonia fuel supply system
IACS	International Association of Classification Societies
IGC	International Code for the Construction and Equipment of Ships Carrying Liquefied Gases in Bulk
IGF	International Code of Safety for Ships Using Gases or Other Low-flashpoint Fuels
IMO	International Maritime Organization
LNG	Liquefied natural gas
LOA	Length overall
LP AFSS	Low-pressure ammonia fuel supply system
LPG	Liquefied petroleum gas
LR	Lloyd's Register
LR2	Long-range 2 (tanker vessel)
MARPOL	International Convention for the Prevention of Pollution from Ships (Marine Pollution)
MDO	Marine diesel oil
M/E	Main engine
N <sub>2</sub>	Nitrogen gas
NH <sub>3</sub>	Ammonia
NoGAPS	Nordic Green Ammonia Powered Ships
NO <sub>x</sub>	Nitrogen oxides
N <sub>2</sub> O	Nitrous oxide
OpEx	Operating expenses
PEM	Proton-exchange membrane
PPE	Personal protective equipment
PT	Pressure transmitter
QCDC	Quick connect/disconnect coupling
QRA	Quantitative risk analysis
SCR	Selective catalytic reduction
SFSS	Second fuel supply system
SIGTTO	Society of International Gas Tanker and Terminal Operators
SOFC	Solid oxide fuel cell



---

SSL	Ship-shore link
STS	Ship-to-ship
TCO	Total cost of ownership
TCS	Tank connection space
TEU	Twenty-foot equivalent unit
TT	Temperature transmitter
VLCC	Very large crude carrier

---



# References

- 1 [Mærsk Mc-Kinney Møller Center for Zero Carbon Shipping. Preparing container vessels for conversion to green fuels. \(2022\).](#)
- 2 [Mærsk Mc-Kinney Møller Center for Zero Carbon Shipping. Managing emissions from ammonia-fueled vessels \(2023\).](#)
- 3 [Mærsk Mc-Kinney Møller Center for Zero Carbon Shipping. Nordic Green Ammonia Powered Ships \(NoGAPS\) \(2023\).](#)
- 4 [Mærsk Mc-Kinney Møller Center for Zero Carbon Shipping & Lloyd's Register Maritime Decarbonisation Hub. Recommendations for design and operation of ammonia-fueled vessels based on multi-disciplinary risk analysis \(2023\).](#)
- 5 [Lloyd's Register & Mærsk Mc-Kinney Møller Center for Zero Carbon Shipping. Human factors considerations: Ammonia fuel end-of-stage report \(2023\).](#)
- 6 [Mærsk Mc-Kinney Møller Center for Zero Carbon Shipping. Concept design of a 15,000 TEU ammonia-fueled container vessel \(2023\).](#)
- 7 [Mærsk Mc-Kinney Møller Center for Zero Carbon Shipping. Preparing tanker vessels for conversion to green fuels \(2024\).](#)
- 8 [Lloyds Register. Fuel for thought: Ammonia \(2023\).](#)
- 9 [Committee on Acute Exposure Guideline Levels. Committee on Toxicology. National Research Council. Acute exposure guideline levels for selected airborne chemicals: Volume 6 \(2007\).](#)
- 10 [International Maritime Organization. Resolution MEPC.308\(78\). 2018 Guidelines on the method of calculation of the attained energy efficiency design index \(EEDI\) for new ships. adopted 26 October 2018.](#)
- 11 [International Maritime Organisation. Draft MSC Circular. CCC.10 WP.6 Annex 1 Interim guidelines for the safety of ships using ammonia as fuel, September 2024.](#)
- 12 [International Maritime Organization. International code of safety for ship using gases or other low-flashpoint fuels \(IGF Code\) \(2015\).](#)
- 13 [International Maritime Organization. International code for the construction and equipment of ships carrying dangerous chemicals in bulk \(IBC Code\). Resolution MEPC.119\(52\), adopted on 15 October 2024 \(2024\).](#)
- 14 [International Maritime Organization. MSC.1/Circ.1455. Guidelines for the approval of alternatives and equivalents as provided for in various IMO instruments \(2013\).](#)
- 15 [American Bureau of Shipping. Requirements for ammonia fueled vessels \(2023\).](#)
- 16 [Bureau Veritas. Ammonia-fuelled ships — Tentative Rules. NR671671 – July 2022 \(2022\).](#)
- 17 [China Classification Society. Guidelines for ships using ammonia fuel \(2022\).](#)
- 18 [ClassNK. Guidelines for ships using alternative fuels. Part C: Guidelines for the safety of ships using ammonia as fuel \(Edition 3.0.0\) \(2024\).](#)
- 19 [DNV. Rules for classification of ships, Part 6: Additional class notations. Chapter 2: Propulsion, power generation and auxiliary systems. \(Edition July 2023\) \(2023\).](#)
- 20 [Lloyd's Register. Rules and regulations for the classification of ships using gases or other low-flashpoint fuels \(2022\).](#)
- 21 [International Maritime Organization. IGC Code - International Code for the Construction and Equipment of Ships Carrying Liquefied Gases in Bulk \(2016\) \(2016\).](#)
- 22 [Mærsk Mc-Kinney Møller Center for Zero Carbon Shipping. Fuel cell technologies and applications for deep-sea shipping: Technology mapping and techno-economic assessment of fuel cell applications for onboard auxiliary power \(2024\).](#)
- 23 [Han, B., Butterly, C., Zhang, W., He, J., & Chen, D. Adsorbent materials for ammonium and ammonia removal: A review. Journal of Cleaner Production, 283, 124611 \(2021\).](#)





# Appendices

## A. Differences and gaps in current regulations

### Exposure limits

In January 2024, IACS published a unified requirement (URH1) on the control of ammonia releases on ammonia-fueled vessels. When this requirement takes effect on 1 January 2025, a limit of 300 ppm-initiated shutdown of respective equipment supersedes current class requirements for ammonia concentration in locations where leaks may occur. However, it also requires a lower threshold to be applied for necessary actions. Currently, different classes have taken different approaches.

Additionally, the IMO interim guidelines stipulate alarm limits of 25, 110, and 220 ppm, with shutdown being triggered at 220 ppm.<sup>11</sup>

### Emissions to air

From 1 January 2025, IACS UR will supersede existing limits on ammonia releases to the atmosphere set by different classification societies. It requires monitoring all points where ammonia is released into the atmosphere and triggering an alarm at 300 ppm (Table 19).

Currently, most classes require unavoidable ammonia emissions to be reduced to below 25 or 30 ppm before being released into the atmosphere through the ventilation outlet (Table 19), whereas the IMO interim guidelines require all operational discharges to be reduced to below 110 ppm.<sup>11</sup> Some of the classes specify ammonia release management systems such as water scrubbing or dilution with air.

It is difficult to treat all potential ammonia emissions, ranging from pipe pressure release valves, purging of pipes, and fuel tank pressure release through ARMS. Furthermore, it is noteworthy that ammonia carriers currently release tank over-pressure directly into the atmosphere via the vent mast without treatment.

Table 19: Ammonia emission limits to atmosphere.

Emissions to air	ABS, 2023	BV, 2022	CCS, 2022	DNV, 2023	LR, 2022	Class NK, 2024
<b>Alarm limit</b>	300 ppm	30 ppm	N/A	300 ppm	220 ppm	25 ppm, for releases from piping systems
<b>ARMS requirement</b>	Below 25 ppm	Below 30 ppm	Equipment to control ammonia vapor emissions and its arrangement keeps the ammonia concentration at any manned location below the permissible exposure limit.	Below 30 ppm		



---

## Toxic zones

The concept of toxic zones and safe zones has been introduced to address risks related to exposure to ammonia vapors. There are discrepancies in the terminology applied in the class rules.

---

## Disposal of water containing ammonia

Some class rules require separation of water potentially containing ammonia, whereas other rules specify collecting it using a bilge system. For example, ABS foresees that water containing ammonia could be discharged under MARPOL 73/78, Annex II - Regulations for the Control of Pollution by Noxious Liquid Substances in Bulk requirements. It is likely that ammonia discharges will be addressed in future MEPC meetings.

Reducing the ammonia content of the water can be done onboard using, for example, aeration or oxidation, but those processes would convert it into nitrates and nitrites, i.e., the environmental concerns related to eutrophication would not be solved. Further reductions of nitrates and nitrites to nitrogen is a rather complex process.

The environmental impact of small discharges into the open of ammonia-containing water is limited. Today, passenger ships can discharge untreated black water (which can contain more than 100 mg/L ammonia) when outside coastal areas.

Storing water containing ammonia onboard for later disposal onshore is also challenging, as most ports are not equipped with such treatment facilities. Consequently, having such an option will require significant investments in the development of relevant storing and treating facilities on port level. Local port state regulations such as the EU Waste Code should be developed to address new waste products originating from ammonia-powered vessels.

---

## Fuel tank gas freeing

Gas freeing operation is not addressed in the class rules. However, IACS UR H1 considers gas freeing before docking as normal operation, and thus requires that the resulting concentration at locations on the ship where the crew has normal access does not exceed 25 ppm. This must be demonstrated by means of a gas dispersion analysis.

Considering the volumes of ammonia-dry air mixtures released during the operation of gas freeing, it might require a large ARMS to comply with emissions requirements. It is important to note that there is no such requirement in place for the ammonia carriers in operation (carrying ammonia as cargo) right now.

To ensure the maximum safety of the crew, the vessel must be positioned in such a way that any ammonia plume is led away from the ship in the event of gas freeing. This will depend on the wind direction and the location of the vent mast on the ship.

---

## Fuel standard

Today, there is no ISO or other standard defining quality and purity of ammonia bunker fuel. For example, maximum temperature and water content should be agreed before bunkering according to the engine maker requirements.



---

## B. Ammonia fuel system components

---

### Inert gas system

Inert gas is used for inerting the tank hold space and the annular space of the fuel piping (unless mechanically vented double-walled piping is used and purging of the fuel system).

In general, carbonaceous inert gas is not compatible with ammonia. Therefore, the use of flue gas type generators producing CO<sub>2</sub>-rich gas is not recommended. Instead, inerting should be done either by reducing the oxygen content of air or with nitrogen gas. Both gases can be made by pressure swing adsorption or in membrane generators.

Nitrogen gas can either be produced onboard or supplied in bottles. On large-sized dual-fuel ships, the first option is often more feasible economically, as the handling of bottles incurs high operating costs. To limit the consumption of nitrogen gas, dry air can be considered for tank hold space and bunker line purging. Dry air is generated by a dryer, which is usually less expensive than an inert gas generator. Meanwhile, it can be challenging and expensive to install a generator with the capacity required for inerting fuel tank holds and/or cargo tanks since the generator is a large and expensive piece of equipment.

The ship must be able to inert fuel storage hold spaces with inert gas when a complete secondary barrier is required. This could be solved by permanently filling the hold spaces with inert gas. If possible, an alternative is to use dry air and then fill the spaces with inert gas (e.g., from bottles stored onboard) when required.

### Tank connection space

Typically, the TCS is a gas-tight enclosure or room isolating the tank penetrations used for transferring fuel. The TCS can house fuel supply pumps and other fuel storage-related equipment such as sensors. Although the TCS is designed for unmanned operation, the risk of leaks is relatively high, and maintenance arrangements must be considered. On Type A and B tanks, the maintenance arrangement is often on top of the tank (tank dome) while on a Type C tank, it can be placed either on top of the tank or beside it. A TCS located below deck should have a gas-tight design, a sill, and two entries such as hatches. All equipment should be rated for hazardous zone 1 installation. Ventilation of a TCS should be designed for the foreseeable worst-case scenario.

Deep-well pumps for a refrigerated/cryogenic medium are often mechanically driven and designed for a five-year in-tank service interval. There are also retractable designs available which further reduce the need to enter the tank. Equipment such as pumps should have drip trays.

---

### Fuel preparation room

The FPR is any space containing fuel process equipment such as pumps, compressors, and/or vaporizers for fuel preparation purposes. It is classified as hazardous area zone 1 and if it is only separated by a single bulkhead or deck, it may not be located adjacent to accommodation spaces, service spaces, electrical equipment rooms, or control stations. However, this requirement does not apply if the boundaries of the space, such as bulkheads and decks, are provided with suitable thermal protection. The FPR must also be designed to withstand the maximum pressure and the negative pressure caused by vaporization of the liquefied fuel.

Fuel preparation equipment is described in the 'Engine room' section.



---

## Piping systems

Double-walled piping should be used outside gas-tight ventilated machinery spaces, such as the piping between engine room, FPR, and TCS. For example, container and bulk carriers should have measures to protect the ammonia piping against falling objects. Keeping the exposed piping as short as possible reduces the risk and the cost of installation. If a short piping is not possible, it can be protected by installing it below deck or in a pipe trunk.

Valves, flanges, and other fittings are potential sources of leaks. One option is to place these inside gas-tight enclosures connected to ventilation or dedicated rooms like the FPR. By installing, e.g., fuel filters inside a ventilated housing, the risk of exposure during a manual filter inspection can be significantly reduced. Also, flange and valve covers can be considered.

Piping systems for liquid ammonia to consumers should be designed to withstand at least 18 bar (vapor pressure at 45°C) to keep ammonia in the liquid phase. Piping should be designed so that all liquid ammonia can be purged off, for example before maintenance work. Under normal conditions, the purged ammonia should be led to fuel storage tanks or alternatively to ARMS. The double-walled piping should be provided with inspection and drain cocks.

Each space should be equipped with an automatic emergency shutdown valve (ESD) that will close the supply into the space.

NB: Some class rules allow inerting of the annular space of the double-walled piping, whereas others require mechanical ventilation of the annular space.

---

## Bunker station

Bunkering is among the riskiest operations onboard as it involves open piping, lifting heavy hoses, and requires coordination between ships or terminal and ships.

Most classification societies generally follow the IGF Code and require that the bunker station is located on open deck to provide sufficient natural ventilation. If the bunker station is in an enclosed or semi-enclosed compartment it requires an appropriate risk assessment. Since ammonia is a toxic fuel, the bunker station should be designed according to the result of an appropriate risk assessment.

Typically, the bunker station is located midship with good distance to accommodation and other air intakes (at least 10 m). On smaller vessels, special attention is necessary because keeping the required distance may be difficult. On bulk carriers and tankers, it is usually located on an open deck, whereas on container vessels, ROROs, car carriers, and passenger ships, the bunker station is located on the flat side of the vessel as a semi-enclosed compartment.

The bunker station must be designed with measures to handle any spilled fuel safely. A drip tray under the fuel pipe connection may be required to contain spilled fuel safely (Figure 10). In addition, if the coaming or drip tray is arranged on open deck, means for draining rainwater may be required.

Furthermore, additional safety equipment is recommended for the bunker station, such as gas detection, ship-shore link (SSL) for automatic and manual ESD communication, closed circuit television (CCTV), water spray system, drip tray, etc., some of which are already regulated by guidelines from the classification societies.

Preferably, a bunker manifold station should be located above the fuel tanks so that any remaining ammonia in bunkering lines can be drained to the fuel tank by gravity after bunkering. The typical manifold consists of one or several liquid lines and one vapor return.



For refrigerated ammonia, low-temperature sheathing under the bunker station should be considered to protect the ship structure.

The vapor return line should likewise be fitted with shutoff valves, inert gas supply, quick connect/disconnect coupling, and dry-type emergency release coupling.

Ergonomics is an important design criteria as bunkering hoses and couplings are heavy. For the LPG manifold, the Society of International Gas Tanker and Terminal Operators (SIGTTO) recommends that flanges are located not higher than 1,400 mm above the platform and with a minimum distance of 900 mm between the flanges. Additionally, ergonomics can be improved with the help of, for example, an adjustable hose saddle and a receiving bunker arm.

In some cases, for example on a container ship, the location of the bunker station can significantly impact the loadability, as a midship bunker station takes space from containers.

## Engine room

For operation on ammonia and low-flashpoint fuels such as LNG, the engine room is typically designed to be a gas-safe (non-hazardous) space. Ammonia is therefore led through double-walled piping and secondary barriers. Engines are typically designed as gas safe, i.e., with a second enclosure of the fuel system.

The FPR design depends on the consumers. For example, ammonia-fueled ship designs have so far largely focused on the main engine as the only ammonia consumer. However, the target of ongoing development is to power 4-stroke auxiliary engines, boilers, and fuel cells with ammonia as well.

Enclosed spaces should be provided with ammonia detection devices, both close to the floor and in elevated positions. Equipment such as drip trays and bilge wells should also be equipped with ammonia detection. Dividing the fuel preparation space into separate gas-tight spaces can reduce the risk of exposure to leakages, because the crew is exposed to fewer potential leak points during regular maintenance. This division can be done by separating different consumers into different rooms, and by preparing fuel oil and ammonia in different spaces.

Equipment such as fuel filters should have a maintenance-free and self-cleaning design to the extent possible. Special attention should be paid to manual maintenance procedures and crew training.

All feed lines to ammonia consumers should be provided with automatic fail-close type ESD valves in a double block-and-bleed arrangement. Furthermore, special attention should be paid to purge remaining ammonia from the piping system. Purges should be treated before being released into the atmosphere, e.g., in ARMS.

Figure 10: Typical layout of an ammonia bunker station.

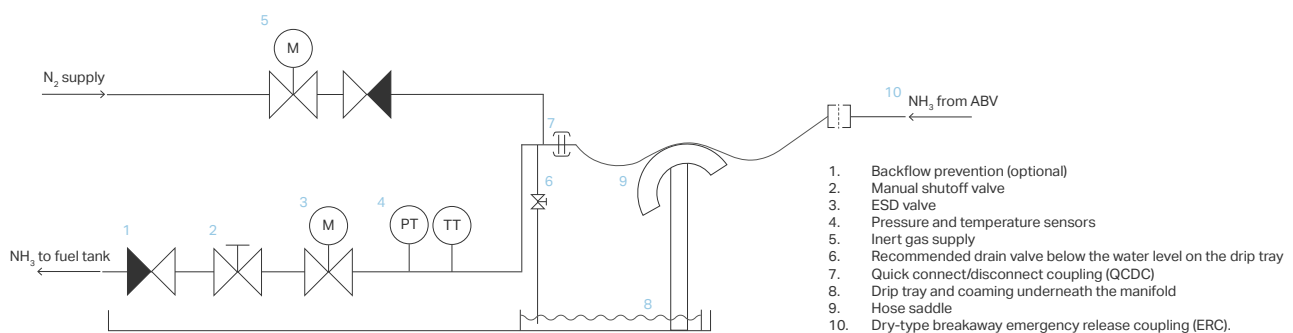

$N_2$  = nitrogen gas, ABV = ammonia bunker vessel, M = motor (can be removed too), PT = pressure transmitter, TT = temperature transmitter, ESD = emergency shutdown



## Engine, fuel cell, and boiler technology

When designing an ammonia-powered ship, it is important to decide whether only the main propulsion is powered by ammonia, or if electricity and heat should be generated from ammonia as well.

Both low-speed dual-fuel 2-stroke and medium-speed 4-stroke main engines are currently being developed for ammonia operation. Small-bore 4-stroke dual-fuel ammonia gensets and ammonia-fired boilers are in an early development phase. Until the ammonia-powered genset becomes available, an axial generator or a conventional fuel-oil-powered auxiliary genset can be used for producing electricity. For the foreseeable future, internal combustion engines, including the ammonia engine, will require pilot fuel oil. However, it is possible to replace fossil pilot fuels with bio-oil to achieve zero emissions.

A gas-safe engine room design requires power converters such as internal combustion engines, fuel cells, gas-fired boilers, or turbines to apply a double-walled design.

## High-pressure ammonia fuel supply system for 2-stroke main engines

Ammonia-fueled 2-stroke engines based on the diesel-cycle principle are being developed and tested using a fuel system based on high-pressure liquid injection.

The fuel preparation system consists of:

- Feed tank
- High-pressure fuel pump
- Heat exchanger
- Duplex strainers
- Polishing filter
- Ammonia recirculation system

As shown in the Figure 11 from the engine incorporated fuel valve rail, the unburned ammonia gas-liquid mixture is fed into a gas-liquid separator, where liquid ammonia is recirculated back to the ammonia feed tank. The gas phase passes through a water column (water seal), which absorbs any ammonia left before it is released into the atmosphere. The same recirculation system recovers ammonia when the engine switches to diesel-burning mode.

As for LNG combustion, preliminary testing suggests that the ammonia combustion requires pilot fuel such as marine gas oil (MGO) or marine diesel oil (MDO). Engine makers are targeting a pilot fuel oil ratio of 5% of energy.

Figure 11: An example of a high-pressure ammonia fuel supply system.

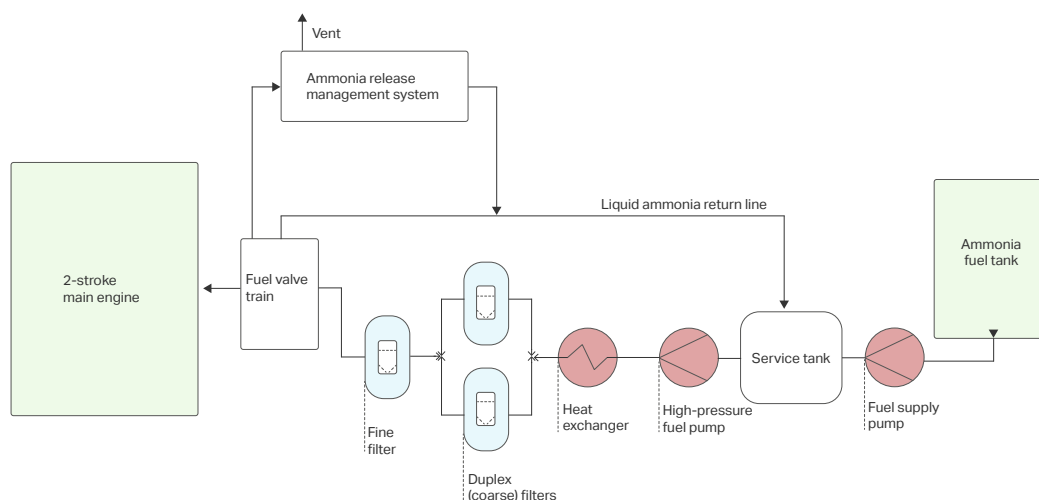

## Low-pressure ammonia fuel supply systems

The first commercially available 4-stroke main engines are of the low-pressure gas injection type. Injecting ammonia in gaseous form requires a higher proportion of pilot fuel (i.e. MDO/MGO) than high-pressure liquid injection. Also, GHG emissions, including nitrous oxide ( $N_2O$ ), are likely to be higher than for a 2-stroke engine.

In a typical low-pressure system (see Figure 12), ammonia is evaporated in a glycol heat exchanger and fed to a gas-tight and explosion-proof enclosure, i.e. the GVU, which houses fuel filters and distribution valves (Figure 12). The ammonia fuel quality is important in a low-pressure gas distribution piping system. Increasing an existing fraction of water can reduce the dew point significantly and lead to unintended condensation. Therefore, the low-pressure (<10 bar) gas piping should be heat traced. If the fuel storage is not pressurized, a booster pump is likely required to supply gas at a sufficient pressure to the GVU.

For the auxiliary 4-stroke genset, leading manufacturers are developing both high-pressure liquid injection and low-pressure gas admission valve type engines.

In general, electricity production onboard requires a holistic approach that considers alternative means like shaft generators and shore power.

## Fuel cells

Ammonia-fueled fuel cell systems are being developed. They can either be used as main electric propulsion power or as a replacement for auxiliary engines.

Currently, there are two pathways:

- Solid oxide fuel cells (SOFC) that produce electricity through a two-stage endothermic reaction at the anode: First ammonia is converted to hydrogen and nitrogen, and in a second reaction, hydrogen reacts with oxygen ions, which pass through the electrolyte from the cathode, and forms water and electrons.
- Catalytic cracking of ammonia combined with proton-exchange membrane (PEM) fuel cells: The catalytic cracker reaction is also endothermic, and ammonia is converted into nitrogen and hydrogen under high pressure and temperature. Hydrogen is fed to the fuel cell where it is oxidized into water, generating electricity.

Due to the early stage of development, only limited information is available regarding purity and pressure requirements, as well as the arrangement of the FPR. Generally, both technologies perform best under steady load and require time to switch on and off due to high process temperatures. More information about fuel cell technology can be found in a recent MMMCZCS publication.<sup>22</sup>

Figure 12: An example of a low-pressure ammonia fuel supply system.

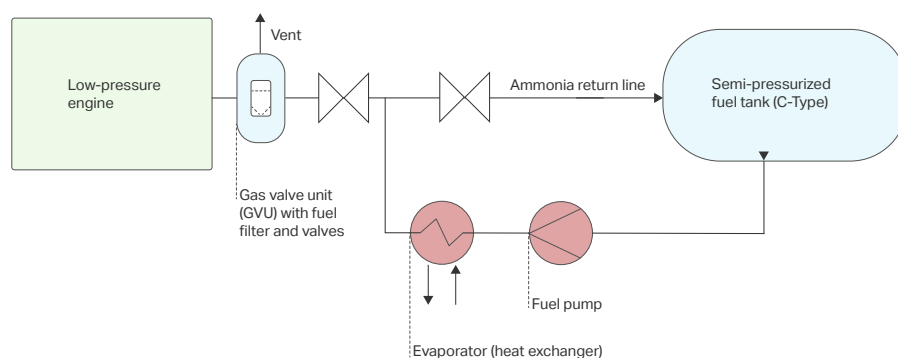

---

## Ammonia-fired boiler

Preliminary testing of the ammonia-fired boiler concept has demonstrated its feasibility, and the development of ammonia-fired boilers is currently underway. However, it is unclear whether the flame temperature is high enough to provide sufficient steam pressure. An ammonia-fired boiler can use either liquid or gaseous fuels. The latter option requires the gas to be compressed and heated, to prevent condensation in the piping. Gas-fed boilers could also use boil-off gas from the storage system. However, considering the relatively low boil-off rate and energy density, a boiler may not be a cost-effective or efficient method for managing boil-off gas.

If a boiler is used to manage ammonia releases, for example from purging of pipes, a start-up delay of a few minutes should be considered.

Fuel-oil-fired or electric boilers are alternative methods that can meet the steam demand of the ship.

---

## Exhaust gas boiler

Especially for 2-stroke engines, the exhaust gas temperature in ammonia mode is likely to be lower than in fuel oil mode. Therefore, the steam pressure generated by an exhaust gas boiler is expected to be lower, especially under winter conditions.

---

## Exhaust gas emission management

Although ammonia is a sulfur- and carbon-free molecule, there are still emissions to consider:

- Ammonia (NH<sub>3</sub>): unburned fuel that slips to the exhaust
- Nitrogen oxides (NO<sub>x</sub>): side product of ammonia combustion and regulated under IMO Tier III
- Nitrous oxide (N<sub>2</sub>O): powerful GHG and a side product of ammonia combustion
- Carbon dioxide, particulate matter, and black carbon emissions related to the use of pilot fuel oil

During engine testing, high-pressure systems seem to produce less N<sub>2</sub>O. Selective catalytic reduction (SCR) and potential ammonia slip (functioning as a reductant) can be used to reduce NO<sub>x</sub> emissions.

Combustion in a low-pressure engine creates N<sub>2</sub>O. Currently, there is no commercially available reduction technology for N<sub>2</sub>O that would function at the ammonia engine exhaust temperatures.

A recent MMMCZCS report covers this topic in more detail.<sup>2</sup>

---

## Ammonia release management

Controlled and uncontrolled ammonia releases should be treated to safe levels before releasing them into the atmosphere. This includes releases under normal operation, such as:

- Pipe purging
- Pressure release from equipment
- Accidental releases, such as equipment failure or leakages in piping

The most efficient means to abate ammonia emissions are combustion, dissolution in water, or adsorption.

---

## Engine combustion

Boil-off gas can be consumed in gas injection engines. It requires a compressor and a heater before feeding the boil-off gas to the main fuel gas system. Considering the low boil-off rate and energy density, it is unlikely that an engine can run on boil-off gas only.

The ammonia-containing water residue from, e.g., ARMS can be burned in a 2-stroke engine.

---

## Gas combustion unit and ammonia-fired boiler

A gas combustion unit (GCU) and a dual-fuel auxiliary boiler are both options for boil-off gas management, but the technology is still under development. An ammonia-fired boiler can produce steam for shipboard use, whereas a gas combustion unit is a safety device.





The main benefit of the GCU is its ability to handle large volumes of ammonia gas, such as in a scenario where a fire leads to a rapid boil-off.

Both boilers and GCUs have start-up times of several minutes, which should be considered in the design. The delay in start-up could be addressed by, for example, waiting for the "system ready" signal or by introducing a buffer tank.

---

## Water absorption

Ammonia readily dissolves into water, forming a basic solution. Therefore, scrubbers and water seals can provide simple, effective, and cost-efficient treatment solutions.

A wet scrubber is a unit in which a gas stream containing ammonia is sprayed with water as it passes through. The efficiency depends on the water surface area and contact time. A large surface area can be achieved by, for example, atomizing the water spray into small droplets or by distributing it over a packing material with a large surface area. A typical closed loop scrubber consists of a spray tower, a pump, and a recirculation tank.

A water seal is typically a tank where an ammonia-containing gas stream is led through an ammonia-absorbing water column. The efficiency can be increased by adding several seals in series. Due to the system's backpressure, it can only treat pressurized gas streams such as pipe purging. The treated gas stream can be released into the atmosphere.

Eventually, the water used for absorption becomes saturated with ammonia and needs to be replaced. Discharging a solution of ammonia in water into the sea is not permitted. Some engine types can combust an ammonia-water solution. Otherwise, this waste product should be disposed of at shoreside treatment facilities.

---

## Adsorption

Low concentrations of ammonia vapor can be contained by adsorption filters. For example, activated carbon, bentonite and zeolite have been found to be effective in adsorbing ammonia.<sup>23</sup> These filters can be used for removing odor, but due to their limited capacity and replacement costs, they are not a feasible option

for removing high concentrations of ammonia such as leakages and pipe purging.

---

## Ventilation outlets and vent mast

Ventilation outlets of enclosed spaces where an ammonia leakage is possible, and outlets of fuel storage tank pressure release valves require special attention. IACS (UR H1) specifies a system design where ammonia fuel is released into the atmosphere during normal operation. If a direct release is unavoidable, a dispersion study must demonstrate that the release does not exceed 25 ppm at locations normally accessible by the crew.

If it is difficult to separate the ammonia vent mast sufficiently from the accommodation on bulk carriers, a drastic change of the arrangement must be considered. The smaller the vessel, the more difficult it is to secure the distance between the ventilation outlet and the accommodation.

As far as possible, all unavoidable and potential releases should be led to a vent mast. The vent mast must be at a distance corresponding to at least the breadth of the ship (B) or 25 m, whichever is shorter from the nearest air intake, air outlet, or opening to enclosed spaces on the vessel.

Some classification societies apply a safe location concept to ventilation outlets similar to the IGF requirement that the storage tank pressure relief valve outlet must be 10 m from the nearest air intake, air outlet, or opening to enclosed spaces on the vessel.

The vent mast and ventilation outlets should be fitted with ammonia detection devices.

The outlets from the fuel tank pressure relief valves must be located at least  $B/3$  or 6 m, whichever is higher, above the weather deck and 6 m above the working area and gangways, where B is the greatest molded breadth of the ship in meters. Note that this is a minimum height by rule and depending on the previously mentioned dispersion analysis, a higher vent mast would be necessary.

The vent mast design must ensure that the discharge is unimpeded and can be directed vertically upwards at the exit to minimize the possibility of water or snow entering the vent system.



# Visit our website for more

[www.zeroarbonshipping.com](http://www.zeroarbonshipping.com)



**Mærsk Mc-Kinney Møller Center**  
for Zero Carbon Shipping

Copyright Notice: ©2024 Fonden Mærsk Mc-Kinney Møller Center for Zero Carbon Shipping. All Rights Reserved. Any publication, display or reference (in whole or in part) of or to this report, shall be made conditional on inclusion of a reference to the Mærsk Mc-Kinney Møller Center for Zero Carbon Shipping.